







More Precision

induSENSOR // Linear inductive displacement sensors



Robust long-stroke sensors for hydraulics & pneumatics

induSENSOR EDS

-  Measuring ranges from 75 ... 630 mm
-  Linearity $\pm 0.3\%$ FSO
-  Integrated controller
-  High resistance to pressure and oil, maintenance free
-  Short offset ranges



induSENSOR EDS long-stroke sensors are designed for industrial use in hydraulic and pneumatic cylinders for displacement and position measurements of pistons or valves, e.g., to measure

- displacement, position, gap
- deflection
- movement, stroke
- filling level, immersion depth and spring travel

The sensor elements of the EDS series are protected by a pressure resistant stainless steel housing. The sensor controller and signal processing are completely integrated in a sensor flange.

An aluminum tube is used as target, which is guided over the sensor rod in a non-contact and wear-free manner. Due to their robust, constructional design, the EDS long-stroke sensors have proven invaluable for integration into hydraulic and pneumatic cylinders and for position monitoring in harsh industrial environments. Due to the eddy current principle applied, no permanent magnets need to be mounted inside the cylinder.

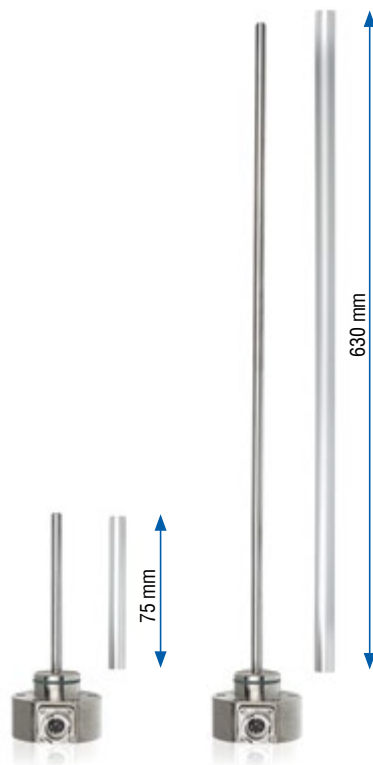

induSENSOR EDS sensors impress with an optimal ratio of compact design and large measuring range. Due to their small offset, the measuring range starts very close to the flange.



Model	EDS-	75 mm	100 mm	160 mm	200 mm	250 mm	300 mm	400 mm	500 mm	630 mm
Series		S	S, F	S, F	S, F	S, F	S, F	S, F	S	S, F
Measuring range		75 mm	100 mm	160 mm	200 mm	250 mm	300 mm	400 mm	500 mm	630 mm
Resolution		0.038 mm	0.05 mm	0.08 mm	0.1 mm	0.125 mm	0.15 mm	0.2 mm	0.25 mm	0.315 mm
Frequency response (-3dB)		150 Hz								
Measuring rate		600 Sa/s								500 Sa/s
Linearity	$\leq \pm 0.3\%$ FSO	$\leq \pm 0.23$ mm	$\leq \pm 0.3$ mm	$\leq \pm 0.48$ mm	$\leq \pm 0.6$ mm	$\leq \pm 0.75$ mm	$\leq \pm 0.9$ mm	$\leq \pm 1.2$ mm	$\leq \pm 1.5$ mm	$\leq \pm 1.89$ mm
Temperature stability		≤ 200 ppm FSO/K								
Supply voltage		18 ... 30 VDC								
Max. current consumption		40 mA								
Analog output ^[1]		4 ... 20 mA (load 500 Ohm)								
Connection	S series	7-pin M9 screw/plug connection (Binder); axial, radial on request (see accessories for connection cable)								
	F series	5-pin bayonet screw plug connection; radial output (see accessories for connection cable)								
Temperature range	Storage	-40 ... +100 °C								
	Operation	-40 ... +85 °C								
Pressure resistance		450 bar (front)								
Shock (DIN EN 60068-2-27)		40 g / 6 ms in 3 axes, 1000 shocks each 100 g / 6 ms radial, 3 shocks each 300 g / 6 ms axial, 3 shocks each								
Vibration (DIN EN 60068-2-6)		± 2.5 mm / 5 ... 44 Hz, 10 cycles each ± 23 g / 44 ... 500 Hz, 10 cycles each								
Protection class (DIN EN 60529) ^[2]		IP65 (F series) / IP67 (S series)								
Material		Stainless steel (housing); aluminum (measuring tube)								

^[1] Optional voltage output (1 ... 5 V) with connection cable C703-5/U for EDS, S series

^[2] Models with plug connection only with suitable and connected mating plug

Model S

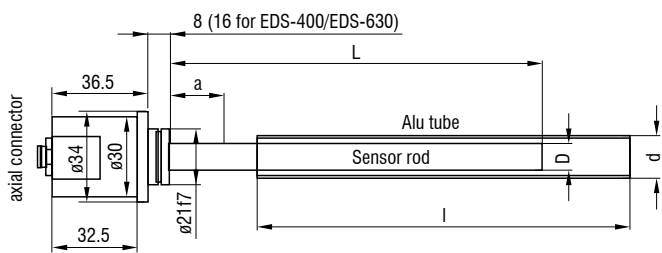

Model F

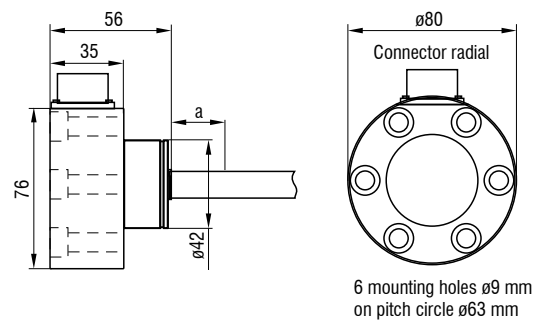

Article designation

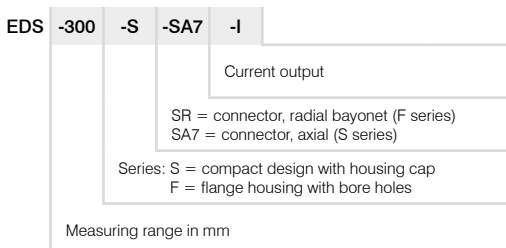

Measuring ranges	Sensor rod		Aluminum tube				Offset
	L	D	l	d	a		
75	110	10	110	16	15		
100	140	10	140	16	20		
160	200	10	200	16	20		
200	240	10	240	16	20		
250	290	10	290	16	20		
300	340	10	340	16	20		
400	450	12	450 (S) 460 (F)	18 (S) 26 (F)	25		
500	550	12	550	18	25		
630	680	12	680 (S) 690 (F)	18 (S) 26 (F)	25		

Mounting options and accessories

indu**SENSOR** EDS

Accessories for S series

Connection cables

C703-5 EDS connection cable for S series, 7-pin, length 5 m

C703-5/U EDS connection cable for S series, 7-pin, length 5 m, for voltage output 1 - 5 V

C703/90-5 EDS connection cable for S series, 7-pin, length 5 m with 90° angled cable connector

Mating plug, S series

Spare tubes

Measuring tube for EDS-75-S	Spare tube
Measuring tube for EDS-100-S	Spare tube
Measuring tube for EDS-160-S	Spare tube
Measuring tube for EDS-200-S	Spare tube
Measuring tube for EDS-250-S	Spare tube
Measuring tube for EDS-300-S	Spare tube
Measuring tube for EDS-400-F	Spare tube
Measuring tube for EDS-630-F	Spare tube

Mounting ring

0483326 EDS mounting ring

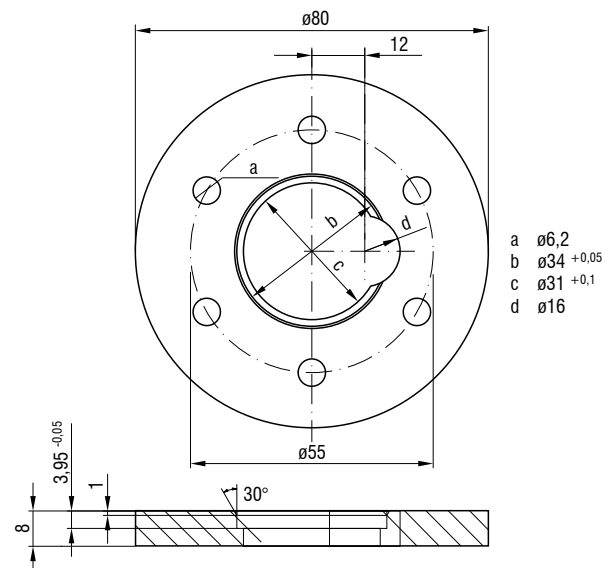

Accessories for the F series

Connection cables

C705-5 EDS connection cable for F series, 5-pin, length 5 m

C705-15 EDS connection cable for F series, 5-pin, length 15 m

EDS connector kit, F series

Spare tubes

Measuring tube for EDS-100-F	Spare tube
Measuring tube for EDS-160-F	Spare tube
Measuring tube for EDS-200-F	Spare tube
Measuring tube for EDS-250-F	Spare tube
Measuring tube for EDS-300-F	Spare tube
Measuring tube for EDS-400-F	Spare tube
Measuring tube for EDS-630-F	Spare tube



EDS-F: Measuring the grinding gap in crushers



EDS-S: Lift height measurement in pneumatic cylinders; flange outside the cylinder



EDS-Z: Integration in hydraulic cylinders; integrated flange and M12 built-in plug

EDS Long-stroke sensors

The measuring principle of the EDS series is based on the eddy current effect. The displacement transducer consists of a measurement coil and a compensation coil which are integrated into a pressurized sensor rod composed of stainless, non-ferromagnetic material. An aluminum tube which can be moved along the housing without making contact is used as the target.

If both coils are supplied with an alternating current, then two orthogonal magnetic fields are produced in the sleeve. The field produced from the single-layer measuring coil has a magnetic coupling with the tube. Therefore, the eddy currents produced in the tube form a magnetic field, which influences the impedance of the measuring coil. This changes linearly with the target position. The magnetic field of the compensation coil has in contrast no coupling with the target and the impedance of the compensation coil is largely independent of the target position.

The electronic circuit generates a signal from the ratio of the impedance of the measurement coil and the compensation coil and converts the sleeve position into a linear electrical output signal of 4 - 20 mA. This significantly eliminates the effects of temperature.

Block diagram EDS series

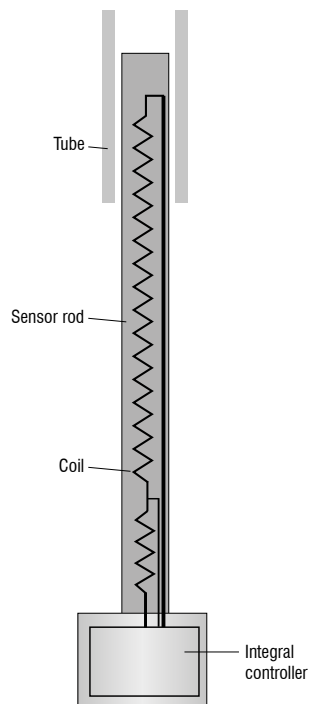

Sensors and Systems from Micro-Epsilon



Sensors and systems for displacement, position and dimension



Sensors and measurement devices for non-contact temperature measurement



Measuring and inspection systems for quality assurance



Optical micrometers, fiber optics, measuring and test amplifiers



Color recognition sensors, LED Analyzers and inline color spectrometers



3D measurement technology for dimensional testing and surface inspection