



# More Precision

**induSENSOR** // Linear inductive displacement sensors



# Inductive displacement and position sensors





## induSENSOR

### Inductive displacement sensors for numerous measurement tasks & industries

For decades, Micro-Epsilon has been renowned for its inductive displacement sensors and gauges and has extended the range of proven measurement techniques such as, e.g., LVDT by further innovative developments. Electromagnetic induSENSOR

displacement sensors from Micro-Epsilon are used extensively in applications for automated processes, quality assurance, test rigs, hydraulics, pneumatic cylinders, and building monitoring. Typical measurement tasks require a long service life and reliability.

#### Wide range of standard sensors





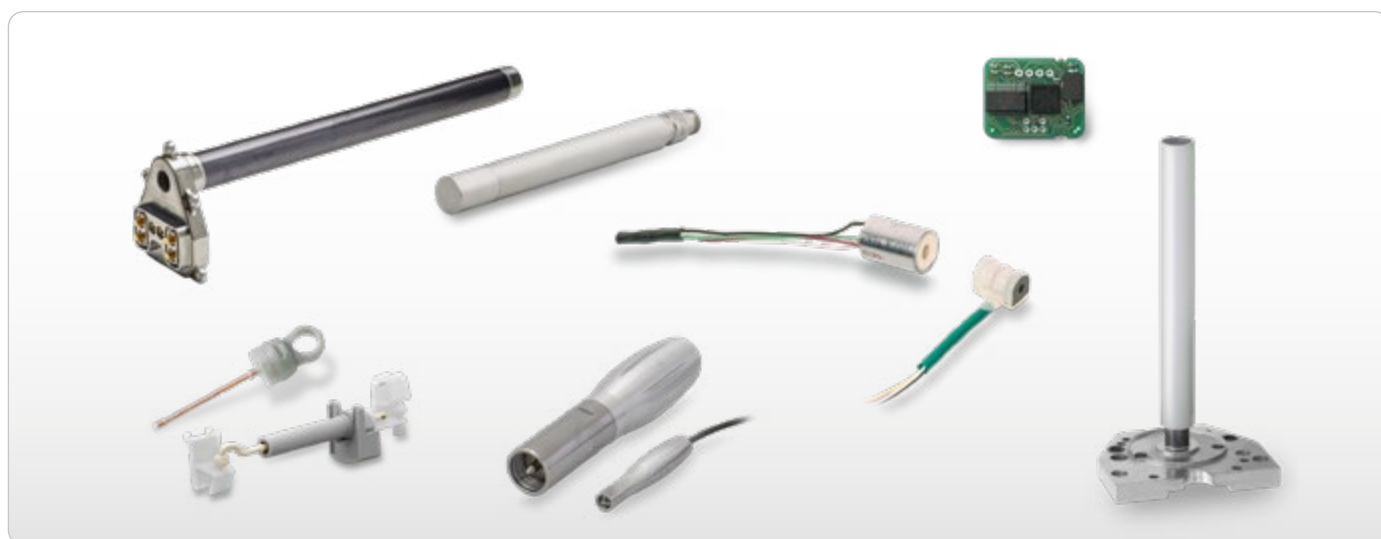







<p>Gauges with external controller</p>  <p>DTA Gauges</p> <p>Measuring ranges: <math>\pm 1 \dots \pm 10</math> mm</p>	<p>Displacement sensors with external controller</p>  <p>DTA Sensors</p> <p>Measuring ranges: <math>\pm 1 \dots \pm 25</math> mm</p>	<p>Linear displacement sensors</p>  <p>LDR</p> <p>Measuring ranges: 10 ... 50 mm</p>	<p>Robust long-stroke sensors for hydraulics &amp; pneumatics</p>  <p>EDS</p> <p>Measuring ranges: 75 ... 630 mm</p>
LVDT			

#### Customized sensors for industrial series applications

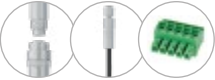

Micro-Epsilon has the experience and the required resources to provide solutions starting from the basic idea through to series production, all from one source – and at a convincing price/performance ratio. A team of specialist development and application engineers implements

concepts and designs according to customer-specific requirements. All project members are involved in development, prototype construction and series production.

Introduction		Page
	Advantages of inductive sensors	4 - 5
	Ideal for customer-specific adaptations	6 - 9
	Modular measurement chains and interfaces	8 - 11
Model		Page
	Inductive displacement measuring system	12 - 13
	LVDT Gauges	14 - 17
	LVDT Displacement sensors	18 - 21
	LDR Displacement sensors	22 - 25
	Sensors for displacement measurements of rotating shafts	26 - 27
	Compact sensor controllers MSC7401 / MSC7802	28 - 31
	Sensor controller MSC7602	32 - 33
	Connection possibilities	34 - 35
	EDS Long-stroke sensors	36 - 39
Technology		Page
	Measuring principle	40 - 43

# Advantages induSENSOR

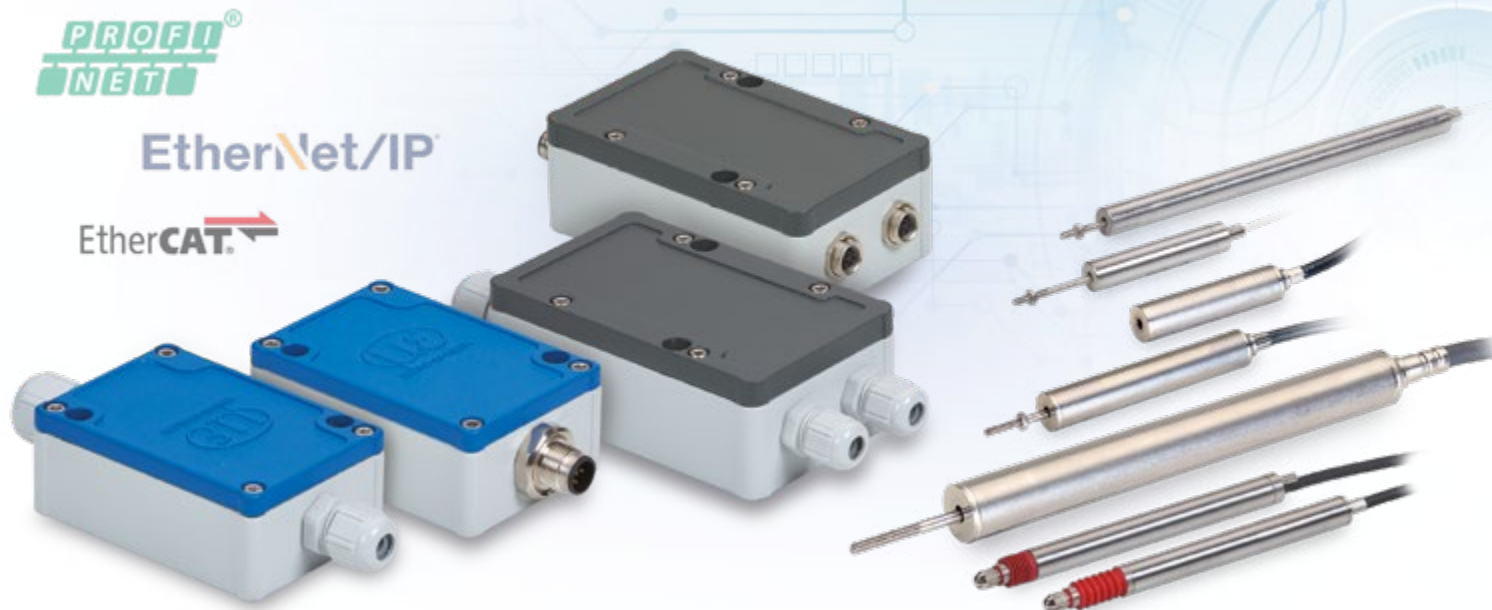

PROFI  
NET

EtherNet/IP

EtherCAT

## Powerful controllers with more precision

Inductive displacement sensors from Micro-Epsilon impress with their robustness, reliability under harsh conditions, high signal quality and temperature stability. Combined with the modern MSC controller generation, numerous application fields and possibilities are opening up. Each sensor can be operated with every controller. Digital interfaces, operation via software and inclusion into bus environments support integration into different industries.

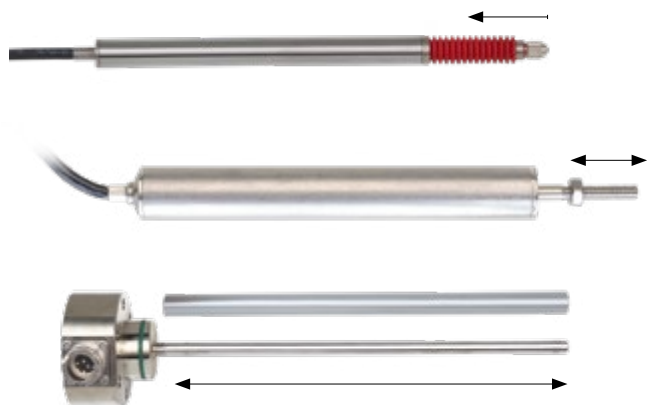

## Numerous measuring ranges for multiple measurement tasks

Inductive displacement sensors cover a variety of measuring ranges. Common LVDT displacement sensors and gauges are best suited to measuring ranges up to  $\pm 25$  mm. For large measuring ranges up to 630 mm, EDS long-stroke sensors are suitable.

## Plunger, aluminum tube and probe tips

The different sensor series are equipped with different targets. Plunger, aluminum tube and probe tips can be selected and adapted for mechanical integration. Accurate mounting enables non-contact and wear-free measurements.



### Long mechanical service life

The induSENSOR series is designed in such a way that there is usually no contact between the target and the sensor. Therefore, no parts rub against each other or wear out. As a result, the inductive displacement sensors from Micro-Epsilon achieve a long mechanical service life.

This is favorable for measurement tasks requiring high reliability, e.g., in industrial factory and process automation, in aviation and aerospace as well as power plants and research facilities.

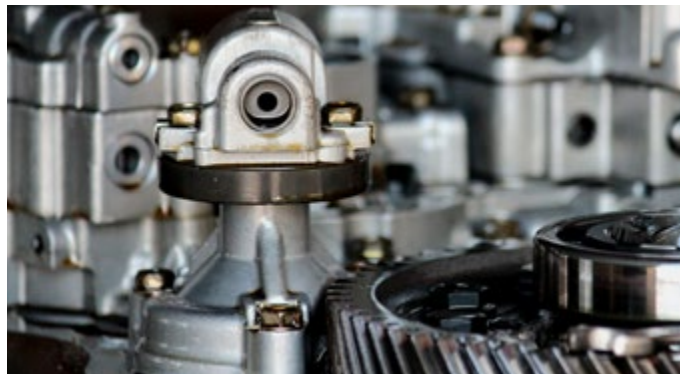

### Ideal for harsh ambient conditions

The induSENSOR models stand out due to their robustness and reliability under harsh conditions. As they provide high signal quality, temperature stability, resistance to shocks and vibrations as well as insensitivity to dirt and humidity, these sensors are the preferred choice for industrial measurement tasks.

### High repeatability and signal stability

Inductive sensors from Micro-Epsilon impress with their exceptional precision. Based on advanced technologies, these sensors provide resolutions down to the micrometer range. Combined with high signal stability, the induSENSORS impress in measurement tasks where high accuracy is required.

### Versatile integration possibilities with analog and digital interfaces

The MSC controllers convert the induced voltage into a standardized output signal. Depending on the controller, analog output types or digital outputs are available. For customer-specific sensor developments, the controller can be integrated directly into the sensor.

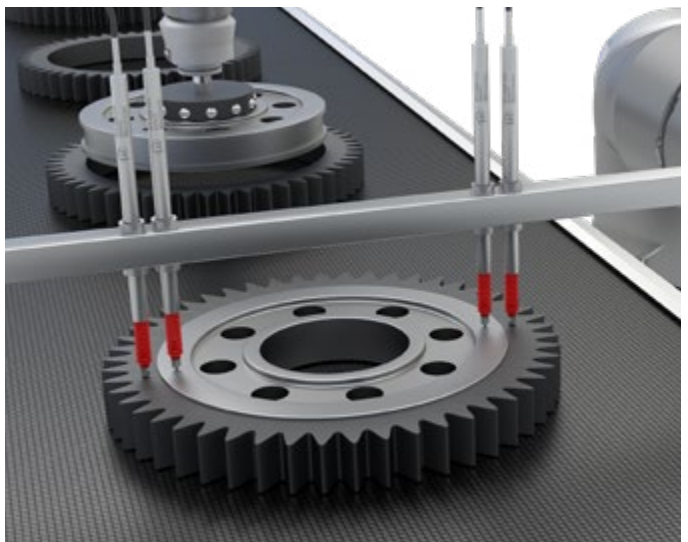

# Ideal for customer-specific adaptations

## induSENSOR

### High Modularity & OEM Capability

#### From minor adaptations of standard products ...

If the standard models do not meet certain specific requirements, inductive sensors from the standard range can be adapted accordingly by Micro-Epsilon. Cost-effective implementation can already be achieved with medium-sized quantities (depending on the type and number of changes). Standard induSENSOR models form the basis for these modifications.

#### Ambient conditions

Depending on the location, environment, and application, different environmental conditions occur to which the sensors are adapted:

- Ambient temperature
- Pressure
- Interference fields
- Dirt, dust, and moisture
- Vibration, shock
- Suitable for seawater, IP69K

#### Basic types

Three basic types are available. Based on these technologies, measuring ranges and target versions can be used with each other.

Technology	Measuring range	Target
① EDS	up to 800 mm	Tube
② LDR	up to 150 mm	Plunger / Probe tip
③ LVDT	up to $\pm 100$ mm	Plunger / Probe tip

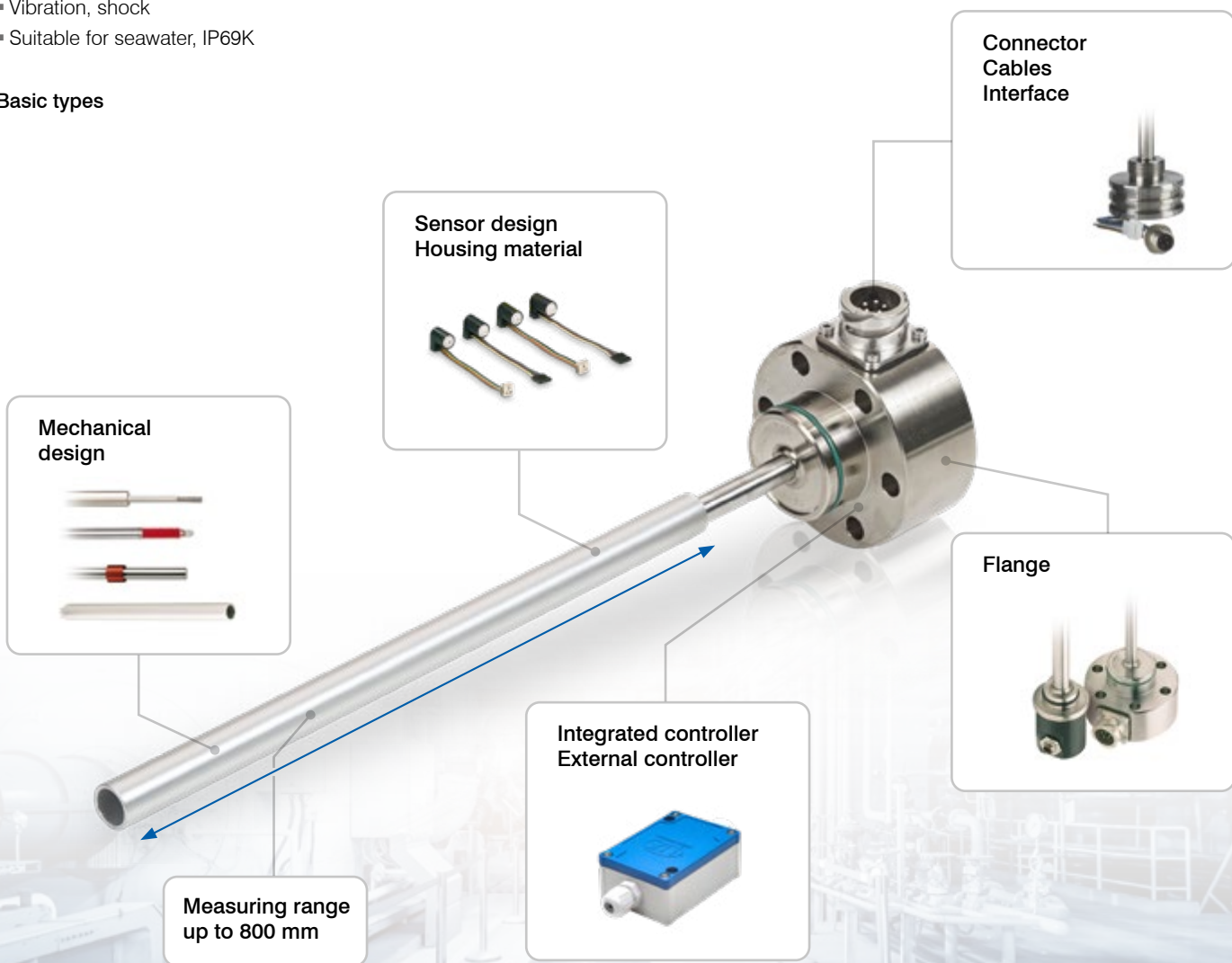

## ... to individual customized solutions

For applications with large quantities, Micro-Epsilon develops sensors that are precisely tailored to customer's requirements. Geometry, controllers and packaging are custom engineered to suit these specific requirements. Due to the high vertical range of manufacturing at Micro-Epsilon, large quantities can be produced at low cost.

### Fields of application

Customized OEM displacement sensors are often developed for fields of application where the highest standards apply:

- Applications with high ambient pressure
- High temperature environments
- Vacuum
- EX environments
- Contaminated installation and measuring rooms

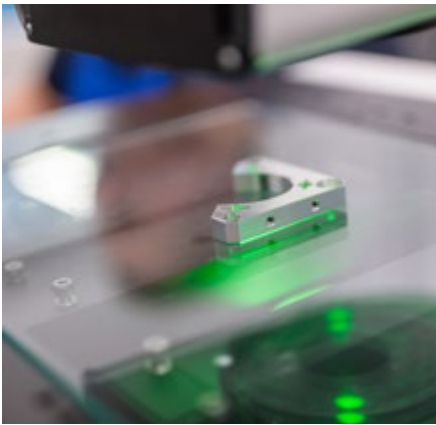

## Series production

**At the Micro-Epsilon headquarters, development projects are initiated and major projects coordinated. The development and sales of specific sensors for OEM customers in large quantities takes place in direct contact with the development and product specialists.**

For series production of controllers, modern and automated production systems for screen and silk-screen printing with vision systems, automatic SMD assembly, reflow soldering in computer controlled convection ovens, CFC-free washing in multi-compartment washing systems, automatic die bonding and laser trimming are available.

With production capacities of more than 1 mill. sensors/year and the use of company-internal resources, the sensors are reasonably priced.

**The production equipment for sensors includes the following:**

- CNC lathes and milling machines
- Fully automatic four-spindle winding machine
- Arc welding equipment for welding the coil wires
- Varnish dip system for protecting the coil
- Automatic inspection system for testing the coil parameters
- Laser welding and marking systems
- etc.

All production systems are supplied in ergonomic and installation-friendly packaging units. In this respect, environmentally friendly and economical reusable packaging is used. Within the scope of Total Quality Management, a 100% check is integrated for numerous measurement and inspection processes.





# Ideal for customer-specific adaptations

## induSENSOR

### Examples for customer-specific modifications

#### Special Systems

- Mechanical adaptations
- ATEX/FM approval
- Additional physical principles



#### Miniature LVDTs

- Small measuring ranges and designs for installation into confined spaces

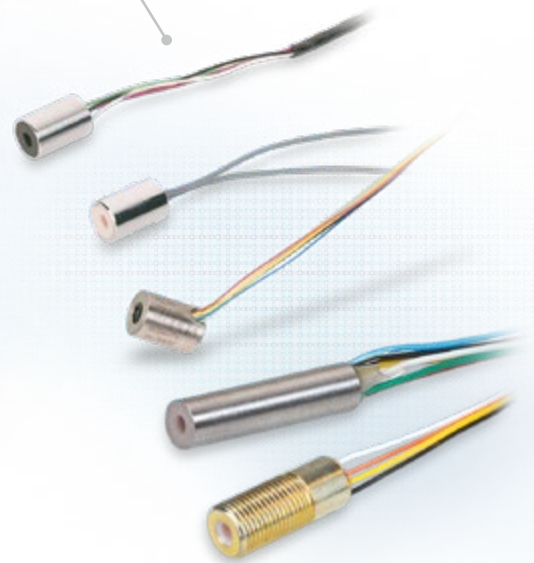

#### Optimized Sensor Technology for Large Series

- Hydraulic valves
- Process valves
- White goods

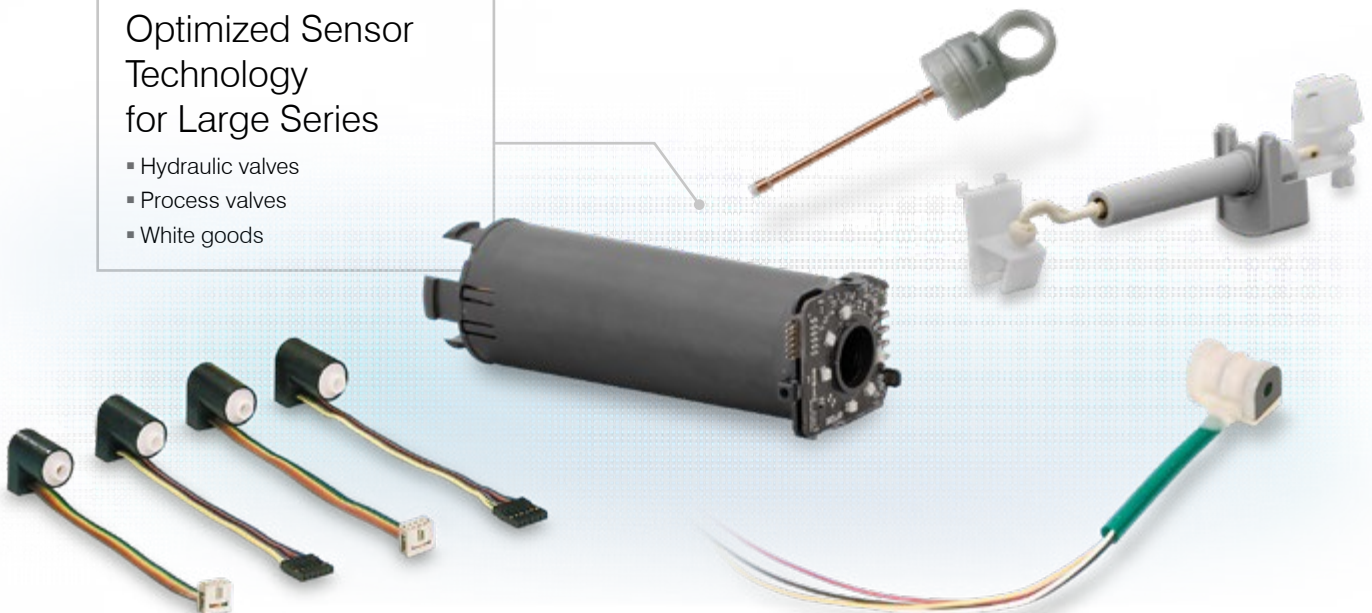



## Eddy Current Long-Stroke Sensors

- High resistance to shocks, vibrations and pressure
- Adapted flanges and connectors for optimal integration
- External controllers for high temperature applications
- Miniature designs for confined installation spaces
- Designs with aluminum tube or plunger



## Adapted Controller Components and Sensor Controllers

- Based on ASICs, analog or digital circuit technology
- Different shapes and connection options
- Miniature designs
- Different output signals and interfaces

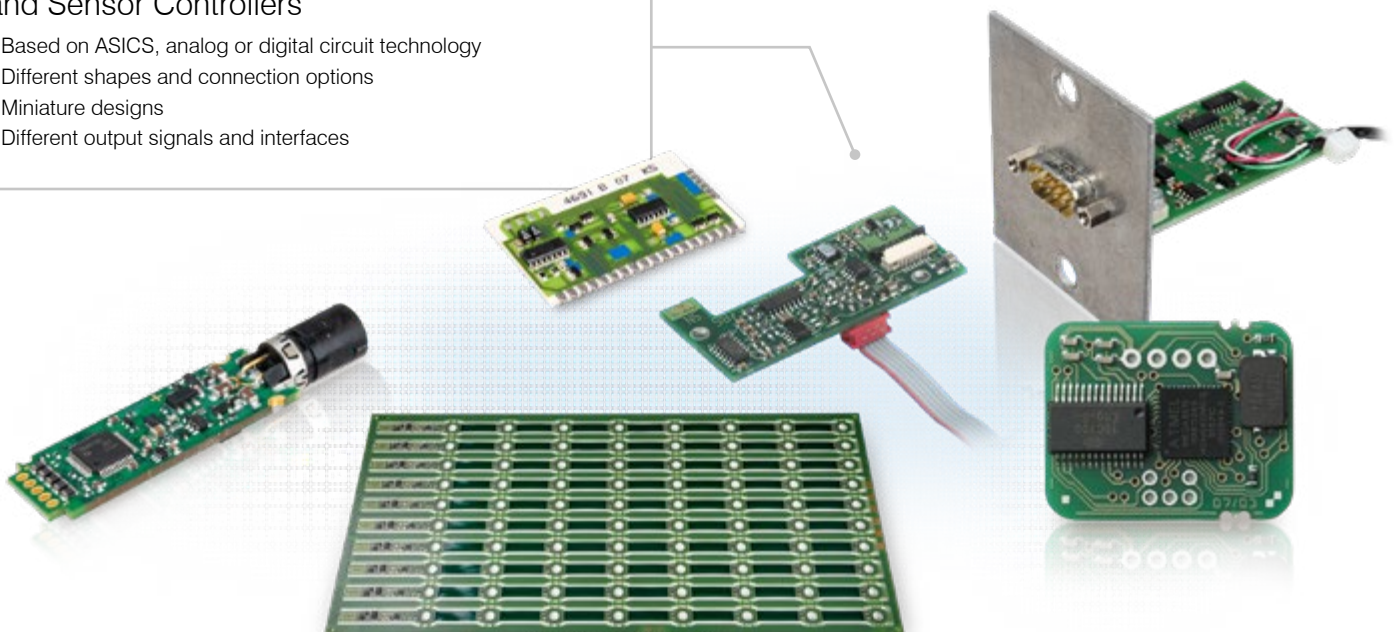



**Sensor-level services:**

Connector assembly, cable reduction



Mounting accessories / Probe tips

**induSENSOR**

**Sensors**



**Gauge: DTA-xG8 series**  
Page 14 - 17



**Sensor: DTA-xDX series**  
Page 18 - 21



**Sensor: LDR series**  
Page 22 - 25



**Sensor: LVP/LDR series**  
Page 26 - 27

**Controllers**



**Single-channel system**  
**Controller MSC7401**  
Page 28 - 31



**2-channel system**  
**Controller MSC7802**  
Page 28 - 31



**Multi-channel system**  
**Controller MSC7602**  
Page 32 - 33

**Measuring system**



**Sensor: DTD-xG8 series** Page 12 - 13



**System-level services:**



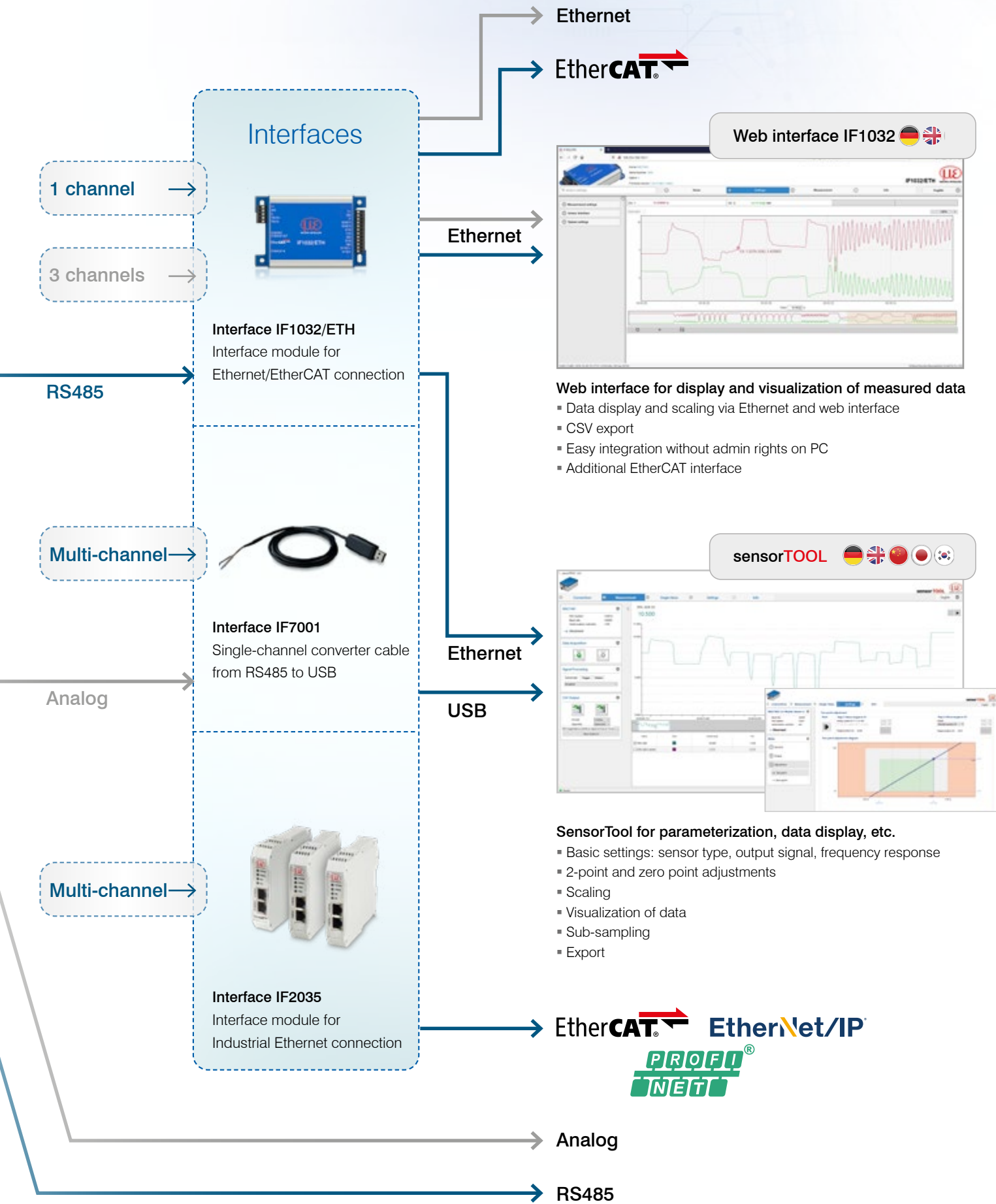



Adjustment, linearization, basic settings, test certificates





# Inductive displacement measuring system

## induSENSOR DTD-xG8

-  Compact measuring system
-  Proven LVDT technology with high resolution
-  Excellent price/performance ratio
-  Measuring ranges  $\pm 1 \dots \pm 10$  mm
-  Robust design for industrial applications
-  Ideal for serial applications in machine building and automation



### Compact design

The compact DTD inductive displacement measuring system consists of a DTA gauge with a plunger guided by a plain bearing and a controller, which are connected to each other with a cable. This system is ideal for the integration in machines as it requires only little installation space. The controller has a diameter of just 18 mm and the 3m-long cable enables flexible installation.

### Characteristics & design

The DTD system is based on the proven LVDT technology. It impresses with outstanding precision and provides resolutions down to the micrometer range. The system is available for the measuring ranges  $\pm 1$  mm,  $\pm 3$  mm,  $\pm 5$  mm and  $\pm 10$  mm which cover numerous measurement tasks. Due to the high system signal stability, the induSENSOR DTD impresses in measurement tasks where high accuracy is required. The controller has a compact and robust housing made of stainless steel. As it provides high temperature stability, resistance to shocks and vibrations as well as insensitivity to dirt, this system can be used for industrial measurement tasks. The system also has an excellent price-performance ratio, which is particularly profitable in applications involving large quantities.

### Interfaces & connections

The system has a lot of analog and digital interfaces. Modern fieldbuses such as Ethernet, PROFINET or EtherCAT are also supported via optionally available interface modules. If needed, parameter setting of the system can be carried out via powerful software or a web interface.

### Applications

The DTD system is preferably used in applications for high precision measurement and inspection of workpiece geometry. It is ideal for series applications in machine building and automation technology.



Spring-loaded plunger

### Article designation

DT	D	-5	-G8	-KE	-3	-CC3	-SA
							Connection (axial): 5-pin SA connector M12
							Connection cable 3 m
							Linearity: 0.5 ( $\pm 0.05\%$ )
							Cable electronics
							Function: gauge
							Measuring range in mm
							Excitation DC
							Principle: Differential Transformer (LVDT)



Model	DTD-1G8	DTD-3G8	DTD-5G8	DTD-10G8	
Measuring range	±1 mm	±3 mm	±5 mm	±10 mm	
Resolution <sup>[1]</sup>	13 bits (0.012 % FSO) at 50 Hz 12 bits (0.024 % FSO) at 300 Hz				
Frequency response (-3dB)	Standard setting: 50 Hz; up to 300 Hz via software				
Linearity <sup>[2]</sup>	≤ ±1 μm	≤ ±3 μm	≤ ±5 μm	≤ ±10 μm	
Repeatability <sup>[3]</sup>	≤ ±0.05 % FSO				
	≤ 0.15 μm	≤ 0.45 μm	≤ 0.75 μm	≤ 1.50 μm	
Temperature stability	Sensor	≤ 250 ppm FSO/K			
	Controller	≤ 100 ppm FSO/K			
Supply voltage <sup>[4]</sup>	14 ... 30 VDC (5 ... 30 VDC)				
Max. current consumption	40 mA				
Digital interface <sup>[5]</sup>	RS485 / PROFINET / EtherNet/IP / Ethernet / EtherCAT				
Analog output <sup>[3] [6]</sup>	(0) 2 ... 10 VDC / 0.5 ... 4.5 V / 0 ... 5 V (Ra 1 kOhm) or 0 (4) ... 20 mA (load 500 Ohm)				
Connection	Output side	5-pin connector M12 (cable see accessories)			
	Sensor side	Sensor: integrated cable, length 3 m (±50 mm), min. bending radius: fixed installation: 8x diameter (25 mm) moving: 12x diameter (38 mm) drag chain: 15x diameter (47 mm)			
Mounting <sup>[7]</sup>	Circumferential clamping				
Temperature range	Storage	-40 °C ... +80 °C			
	Operation	Sensor (without bellows): -20 ... +80 °C Sensor (with bellows): 0 ... +80 °C Controller: -40 °C ... +85 °C			
Pressure resistance	Atmospheric pressure				
Shock (DIN EN 60068-2-27)	40 g / 6 ms in 3 axes, 2 directions and 1000 shocks each 100 g / 5 ms in 3 axes, 2 directions and 9 shocks each				
Vibration (DIN EN 60068-2-6)	± 1.5 mm / 5 ... 57 Hz in 3 axes, 10 cycles each ± 20 g / 57 ... 500 Hz in 3 axes, 10 cycles each				
Protection class (DIN EN 60529)	Sensor	IP65 (with bellows); IP54 (without bellows)			
	Controller	IP67			
Material	Sensor	Stainless steel (housing); FPM (bellows); PUR (cable sheath); PVC/PP (cable braids)			
	Controller	Stainless steel			
Weight	Sensor	approx. 70 g	approx. 70 g	approx. 75 g	approx. 85 g
	Controller	approx. 50 g	approx. 50 g	approx. 50 g	approx. 50 g
	Overall system	approx. 120 g	approx. 120 g	approx. 125 g	approx. 135 g
Typ. spring forces <sup>[8]</sup>	SMR	1.3 N	0.8 N	1.0 N	0.7 N
	MMR	1.55 N	1.5 N	1.9 N	1.9 N
	EMR	2.0 N	2.5 N	3.0 N	3.5 N
Typ. service life	5 million cycles				

<sup>[1]</sup>Noise: AC RMS measurement via RC low-pass filter of the 1st order with  $f_c = 5$  kHz

<sup>[2]</sup>Independent linearity

<sup>[3]</sup>200 repetitions; each repetition averaged over 100 values

<sup>[4]</sup>V+ = 5 V: no voltage output available; current output: max. load 100 Ω; V+ = 9 V: voltage output: 0.5 V ... 4.5 V or 0 V ... 5 V; current output: max. load 250 Ω

<sup>[5]</sup>Connection via interface module (see accessories)

<sup>[6]</sup>0 V ≤ < 30 mV, 0 mA ≤ < 35 μA; for controllers with current output, the output signal is limited to approx. 21 mA

<sup>[7]</sup>Mounting clamp included in delivery (see accessories)

<sup>[8]</sup>Removing the bellows changes the spring forces

## DTA Gauges

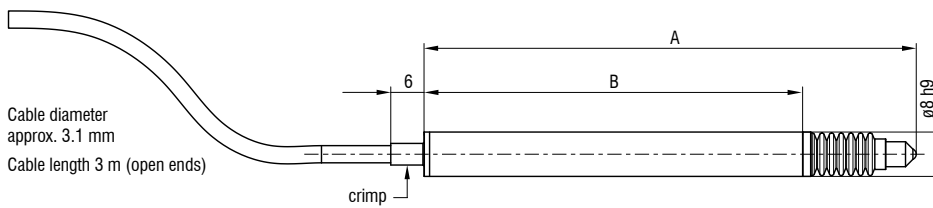

## Controller

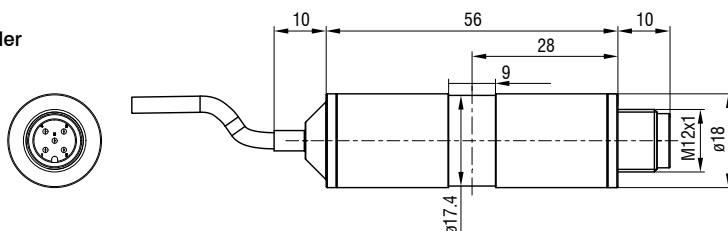

Gauge model	A (zero position)	B
DTA-1G8-3-CA	82.8 mm	64.3 mm
DTA-3G8-3-CA	88.2 mm	68.3 mm
DTA-5G8-3-CA	118.0 mm	89.5 mm
DTA-10G8-3-CA	155.0 mm	121.7 mm



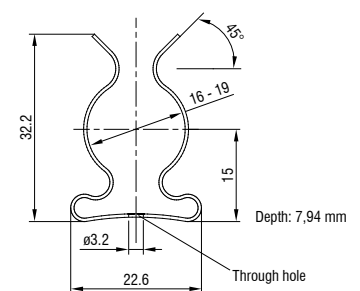

## Mounting clamp



For mounting the controller

# Gauge with external controller for series applications

## induSENSOR DTA (LVDT)

-  Proven LVDT technology
-  Measuring ranges  $\pm 1 \dots \pm 10$  mm
-  Low cost especially for series applications
-  Sensor diameter of only  $\varnothing 8$  mm
-  Models with pneumatic push

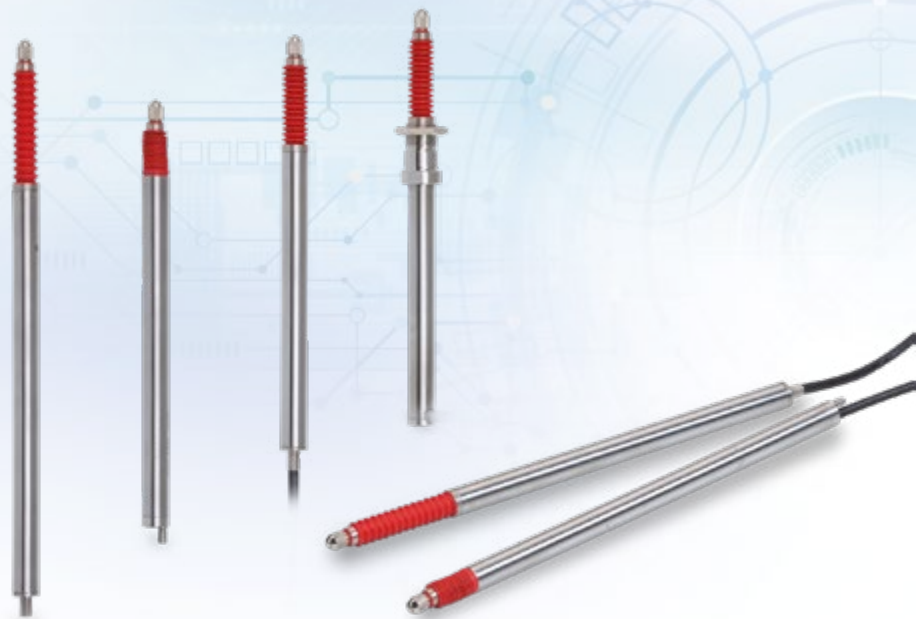

LVDT gauge sensors DTA-xG8 are primarily used for the precise measurement and inspection of workpiece geometry (e.g. length, width, diameter, thickness, depth, height). Therefore, different measuring ranges from  $\pm 1$  mm to  $\pm 10$  mm are available. The gauges are particularly suitable for applications involving a large number of pieces.

These gauges have an axial cable outlet and are equipped with either a plain bearing-guided plunger and a return spring, or with a pneumatic push rod. Depending on the measuring object, different probe tips are available.

DTA gauges can be operated with every MSC controller. Depending on this controller, single-/dual-/multi-channel measurements are possible. In addition to the well-established analog output, modern fieldbuses are available for integration purposes.

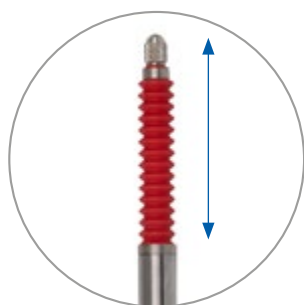

Plunger with spring



Based on modern interfaces and multi-channel capability, the MSC controllers open up new fields of application.

### Article designation

DT	A	-5	-G8	-3	-CA	-V
Gauge options: V: Pneumatic feed						
Connection (axial): CA Integrated cable (3 m)						
Linearity: 3 ( $\pm 0.3\%$ )						
Function: gauge						
Measuring range in mm						
Excitation AC						
Principle: Differential Transformer (LVDT)						





Model	DTA-1G8	DTA-3G8	DTA-5G8	DTA-10G8	DTA-1G8-V	DTA-3G8-V	DTA-5G8-V	DTA-10G8-V
Measuring range	± 1 mm	± 3 mm	± 5 mm	± 10 mm	± 1 mm	± 3 mm	± 5 mm	± 10 mm
Linearity <sup>[1]</sup>	≤ ± 6 μm	≤ ± 18 μm	≤ ± 30 μm	≤ ± 60 μm	≤ ± 6 μm	≤ ± 18 μm	≤ ± 30 μm	≤ ± 60 μm
	≤ ± 0.3 % FSO							
Repeatability <sup>[2]</sup>	≤ 0.15 μm	≤ 0.45 μm	≤ 0.75 μm	≤ 1.5 μm	≤ 0.15 μm	≤ 0.45 μm	≤ 0.75 μm	≤ 1.5 μm
Temperature stability	≤ 250 ppm FSO/K							
Sensitivity	133 mV / mm/V	85 mV / mm/V	53 mV / mm/V	44 mV / mm/V	133 mV / mm/V	85 mV / mm/V	53 mV / mm/V	44 mV / mm/V
Excitation frequency	5 KHz	5 KHz	5 KHz	2 KHz	5 KHz	5 KHz	5 KHz	2 KHz
Excitation voltage	550 mV							
Connection	integrated cable 3 m with open ends; axial cable outlet; drag chain suitable; cable diameter 3.1 mm; min. bending radii: fixed installation 25 mm, moving 38 mm, drag chain 47 mm							
Temperature range	Storage	-40 ... +80 °C						
	Operation	-20 ... +80 °C (without bellows); 0 ... +80 °C (with bellows)						
Pressure resistance	Atmospheric pressure							
Shock (DIN EN 60068-2-27)	40 g / 6 ms in 3 axes, 1000 shocks each							
Vibration (DIN EN 60068-2-6)	± 1.5 mm / 10 ... 58 Hz in 2 axes, 10 cycles each ± 20 g / 58 ... 500 Hz in 2 axes, 10 cycles each							
Protection class (DIN EN 60529)	IP65 (with bellows); IP54 (without bellows)							
Material	Stainless steel (housing); FPM (bellows); PUR (cable sheath); PVC/PP (cable braids)							
Weight	approx. 70 g	approx. 70 g	approx. 75 g	approx. 85 g	approx. 70 g	approx. 70 g	approx. 80 g	approx. 85 g
Typ. spring forces <sup>[3]</sup>	SMR	1.3 N	0.8 N	1.0 N	0.7 N	depending on air pressure		
	MMR	1.55 N	1.5 N	1.9 N	1.9 N			
	EMR	2.0 N	2.5 N	3.0 N	3.5 N			
Compatibility	MSC7401, MSC7802, MSC7602							
Typ. service life	5 million cycles							

<sup>[1]</sup> Independent linearity

<sup>[2]</sup> 200 repetitions; each repetition averaged over 100 values

<sup>[3]</sup> Removing the bellows changes the spring forces

### DTA-xG8-3-CA

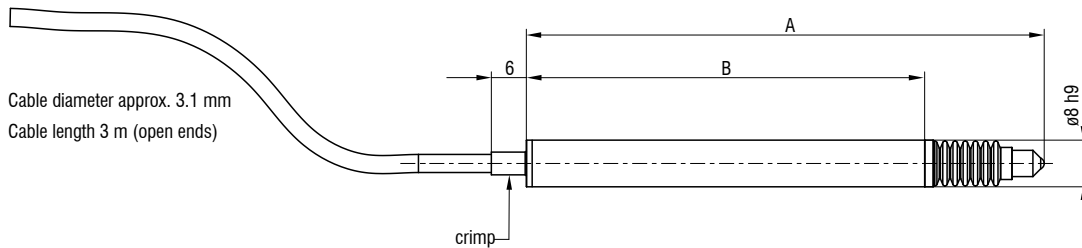

Model	A (zero position)	B
DTA-1G8-3-CA	82.8 mm	64.3 mm
DTA-3G8-3-CA	88.2 mm	68.3 mm
DTA-5G8-3-CA	118.0 mm	89.5 mm
DTA-10G8-3-CA	155.0 mm	121.7 mm

### DTA-xG8-3-CA-V

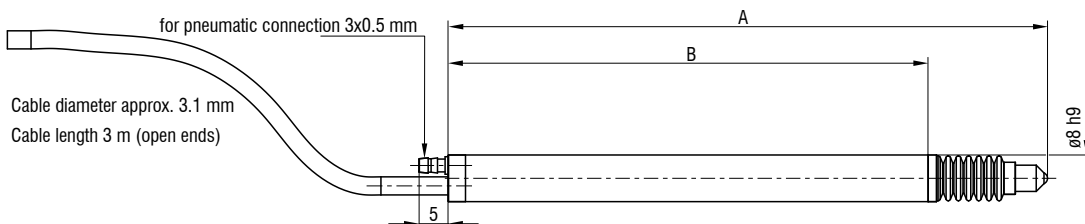

Model	A (zero position)	B
DTA-1G8-3-CA-V	94.8 mm	76.3 mm
DTA-3G8-3-CA-V	102.8 mm	82.3 mm
DTA-5G8-3-CA-V	134.0 mm	105.3 mm
DTA-10G8-3-CA-V	171.0 mm	137.3 mm

Dimensions in mm, not to scale

# Mounting options and accessories

## induSENSOR DTA (LVDT)

### Sensor cables

- C701-3 Sensor cable, 3 m, with cable connector and tin-plated free ends
- C701-6 Sensor cable, 6 m, with cable connector and tin-plated free ends
- C701/90-3 Sensor cable, 3 m, with 90° cable connector and tin-plated free ends
- IF7001 Single-channel USB/RS485 converter for MSC7xxx
- PC5/5-IWT Power supply and output cable, 5 m, M12x1, 5-pin.

Cable connector C701

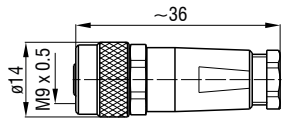

Angle socket C701/90

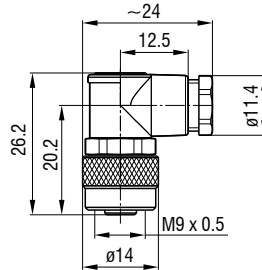

Socket PC5/5

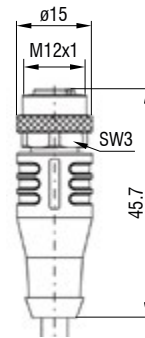

### Service:

- 2981016 Connector assembly M9 and cable reduction  
XXXX mm - DTA-x
- 2980017 Connector assembly M9 - DTA-x
- 2981024 Assembly of screw flange - DTA-xG8

Connector assembly M9  
(see page 34/35)

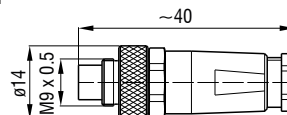

Screw flange

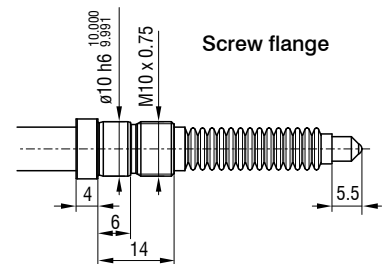

### Probe tips

- Type 2 probe tip / hard metal
- Type 2 probe tip / plastics
- Type 2 probe tip / ruby
- Type 2 probe tip / steel
- Type 10 probe tip / steel
- Type 11 probe tip / steel
- Type 13 probe tip / steel

Standard probe tip: type 2

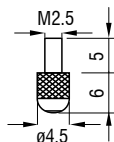

Option: type 10

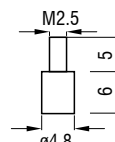

Option: type 11

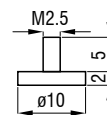

Option: type 13

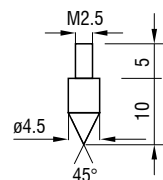

### Sensor Mounting

- 0487087 MBS12/8 Mounting block Sensor mounting for circumferential clamping ø12 mm
- 0487049 MBS12/8 adapter ring For reduction to ø8 mm
- 2966054 Clamping flange for DTA-xG8 For clamping in a defined hole

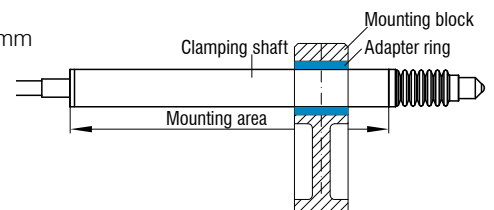

Mounting block MBS12/8

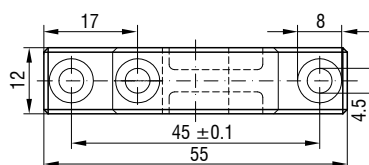
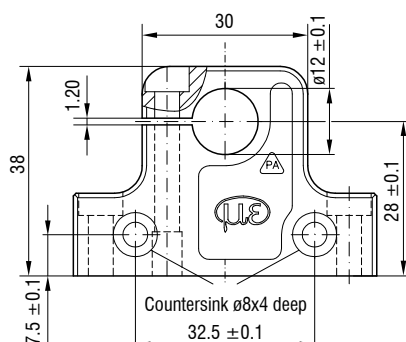

Adapter ring

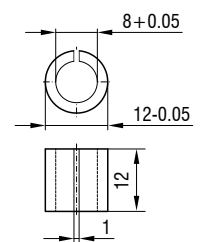

# Applications

## induSENSOR DTA (LVDT)



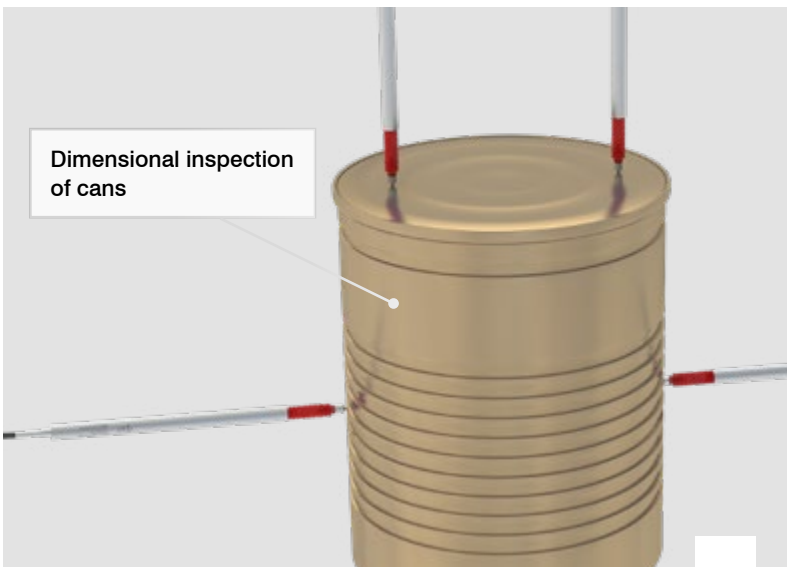
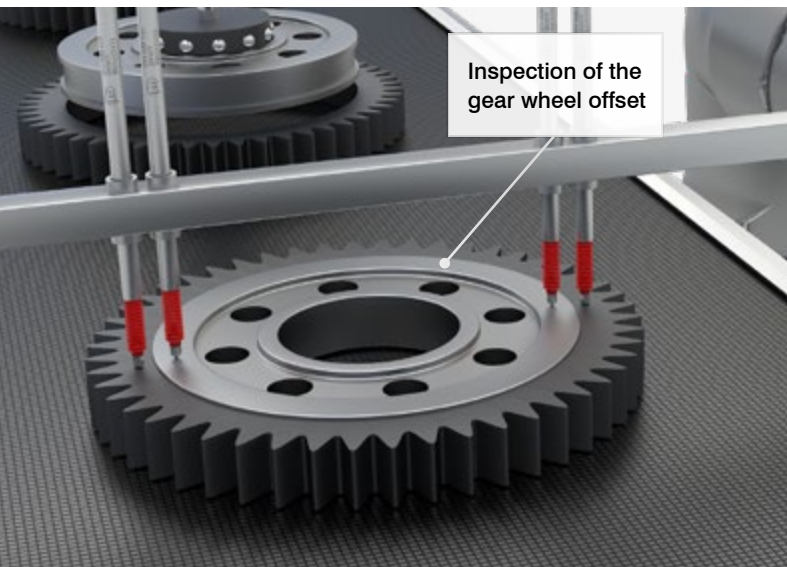
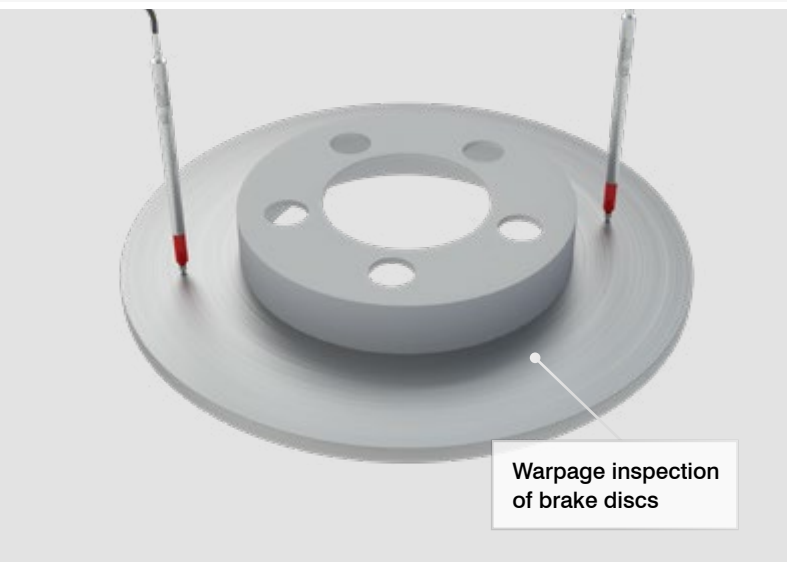
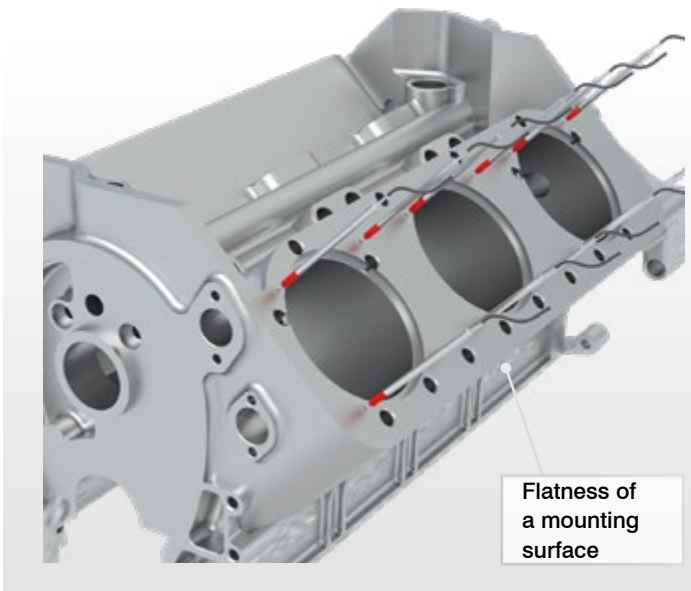

Gauges from Micro-Epsilon have many possible fields of application. Due to different measuring ranges and configuration settings, the gauges are suitable for numerous measurement and inspection tasks. Combined with multi-channel controllers, the DTA gauges are often

used for dimensional measurement and inspection tasks, e.g., in automated quality control, R&D and production monitoring.





# Displacement sensors with external controller indu**SENSOR** DTA (LVDT)

-  Proven LVDT technology
-  Measuring ranges  $\pm 1 \dots \pm 25$  mm
-  Extremely accurate also under difficult ambient conditions
-  Long-term stability
-  Robust design IP67



LVDT displacement sensors have a plunger which moves freely in the sensor housing. The plunger is joined to the object by a thread to transfer the movement of the measuring object. The measurement process in the sensor takes place without contact and is therefore wear-free.

The displacement sensors are primarily used to measure and monitor movements, displacements, positions, strokes, deflections, dislocations, etc. in vehicles, machines and systems.

The high sensor resolution is only limited by the noise of the sensor controller. Another advantage of the symmetric LVDT sensors is their zero point stability.

With appropriate setting possibilities for the excitation frequency and excitation voltage, the sensors can also be operated with alternative controllers.

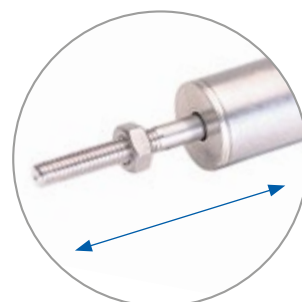

Freely moving plunger

## Article designation

DT	A	-10	-DX	-3	-CA3
Connection (axial): CA Integrated cable (3 m)					
Linearity: 4 ( $\pm 0.4\%$ ) 3 ( $\pm 0.3\%$ ) 2 ( $\pm 0.2\%$ ) 1.5 ( $\pm 0.15\%$ )					
Function: displacement sensor					
Measuring range in mm					
Excitation AC					
Principle: Differential Transformer (LVDT)					



Model	DTA-1DX	DTA-3DX	DTA-5DX	DTA-10DX	DTA-15DX	DTA-25DX	
Measuring range	±1 mm	±3 mm	±5 mm	±10 mm	±15 mm	±25 mm	
Linearity <sup>[1]</sup>	≤ ±0.4 % FSO	-	-	-	≤ ±80 μm	≤ ±120 μm	≤ ±200 μm
	≤ ±0.3 % FSO	≤ ±6 μm	≤ ±18 μm	≤ ±30 μm	-	-	-
	≤ ±0.2 % FSO	-	-	-	≤ ±40 μm	≤ ±60 μm	≤ ±100 μm
	≤ ±0.15 % FSO	≤ ±3 μm	≤ ±9 μm	≤ ±15 μm	-	-	-
	≤ ±0.05 % FSO <sup>[2]</sup>	≤ ±1 μm	≤ ±3 μm	≤ ±5 μm	≤ ±10 μm	≤ ±15 μm	≤ ±25 μm
Temperature stability <sup>[3]</sup>	Zero	≤ 70 ppm FSO/K					
	Max. temp. error	≤ 150 ppm FSO/K					
Sensitivity	127 mV / mm/V	81 mV / mm/V	55 mV / mm/V	45 mV / mm/V	45 mV / mm/V	29 mV / mm/V	
Excitation frequency	5 KHz	5 KHz	5 KHz	2 KHz	1 KHz	1 KHz	
Excitation voltage	550 mV						
Connection	integrated cable 3 m with open ends; axial cable outlet; drag chain suitable; cable diameter 3.1 mm; min. bending radii: fixed installation 25 mm, moved 38 mm, drag chain 47 mm						
Temperature range	Storage	-20 ... +70 °C					
	Operation <sup>[4]</sup> <sup>[5]</sup>	(-40)...-20 ... +90 ... (105) °C					
Pressure resistance	5 bar (front)						
Shock (DIN EN 60068-2-27)	40 g / 6 ms in 3 axes, 1000 shocks each 100 g / 6 ms in 3 axes, 3 shocks each						
Vibration (DIN EN 60068-2-6)	± 1.5 mm / 10 ... 58 Hz in 2 axes, 10 cycles each ± 20 g / 58 ... 500 Hz in 2 axes, 10 cycles each						
Protection class (DIN EN 60529)	IP67						
Material	Stainless steel (housing), PVC-P/TPE-E (cable)						
Weight	Sensor CA	approx. 80 g	approx. 85 g	approx. 90 g	approx. 95 g	approx. 135 g	approx. 145 g
	Plunger	approx. 1 g	approx. 2 g	approx. 2 g	approx. 3 g	approx. 12 g	approx. 16 g
Compatibility	MSC7401, MSC7802, MSC7602						

<sup>[1]</sup> Independent linearity

<sup>[2]</sup> Only valid with linearized controller (factory service can be added to the overall system), observe installation environment

<sup>[3]</sup> Determined using the box method (-20 ... +90 °C)

<sup>[4]</sup> -40 °C with cable at rest

<sup>[5]</sup> up to 105 °C over max. 500h

### Measuring ranges from ±1 to ±10 mm

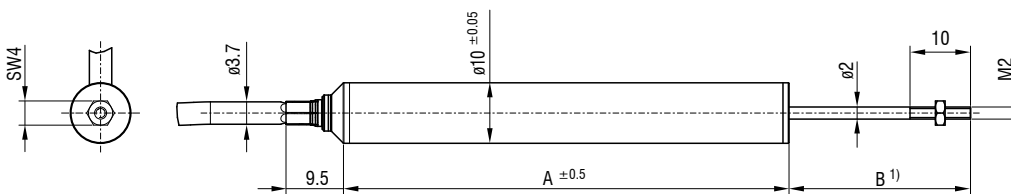

Model	A	B <sup>1)</sup>
DTA-1DX	41.6 mm	17.3 mm
DTA-3DX	58.2 mm	27.2 mm
DTA-5DX	73.7 mm	30.0 mm
DTA-10DX	87.7 mm	35.1 mm

<sup>1)</sup> Plunger in zero position (±1mm ±10 % FSO)

### Measuring ranges from ±15 to ±25 mm

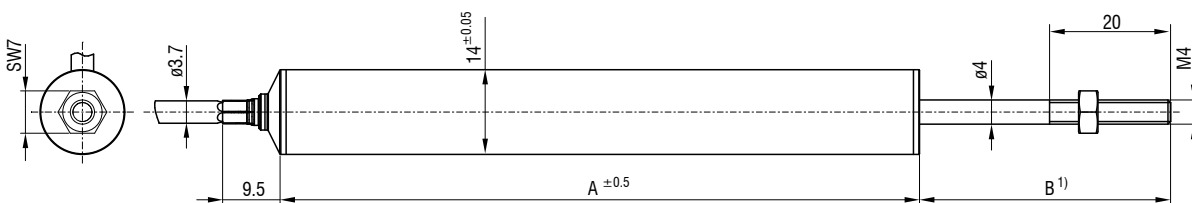

Model	A	B <sup>1)</sup>
DTA-15DX	105.7 mm	46.5 mm
DTA-25DX	140.7 mm	61.5 mm

<sup>1)</sup> Plunger in zero position (±1mm ±10 % FSO)

Dimensions in mm, not to scale

# Options, mounting options and accessories indu**SENSOR** DTA (LVDT)

Sensors with radial cable outlet (on request)



## DTA-xDX-CR

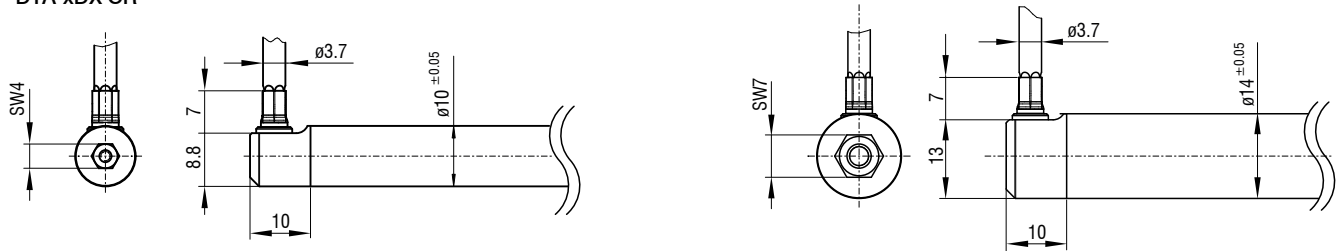

## Service: Assembly of mounting and pressure flange

2981031 Mounting pressure flange DTA-1DX, 3DX, 5DX, 10DX

2981032 Mounting pressure flange DTA-15DX, 25DX



## Mounting pressure flange DTA-1DX, 3DX, 5DX, 10DX

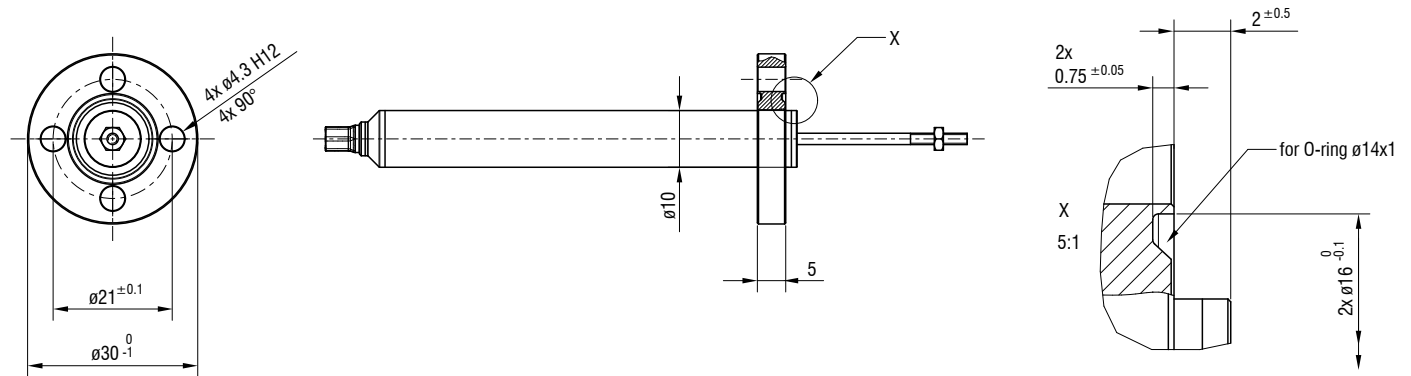

## Mounting pressure flange DTA-15DX, 25DX

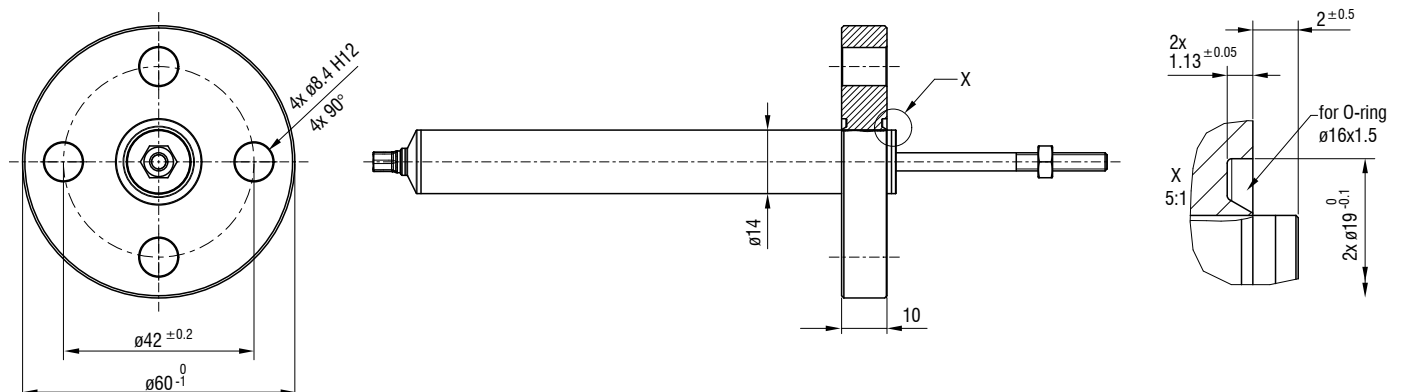

**Service (see page 34/35)**

Connector assembly M9 and cable reduction XXXX mm - DTA-x  
 Connector assembly M9 - DTA-x

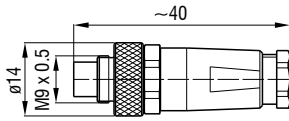

**Sensor Cable**

- C701-3 Sensor cable, 3 m, with cable connector and tin-plated free ends
- C701-6 Sensor cable, 6 m, with cable connector and tin-plated free ends
- C701/90-3 Sensor cable, 3 m, with 90° cable connector and tin-plated free ends

**Cable socket C701**

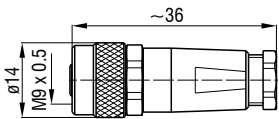

**Angle socket C701/90**

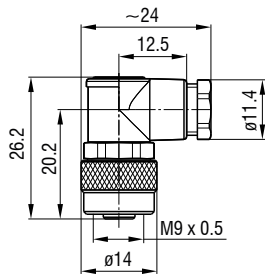

**Spare plungers**

- Plunger for DTA-1DX Spare plunger Plunger for DTA-10DX Spare plunger
- Plunger for DTA-3DX Spare plunger Plunger for DTA-15DX Spare plunger
- Plunger for DTA-5DX Spare plunger Plunger for DTA-25DX Spare plunger

**Sensor Mounting**

- 0483090.01 DTA-F10 Mounting flange, slotted for DTA-1DX, DTA-3DX, DTA-5DX, DTA-10DX
- 04833082 DTA-F14 Mounting flange, slotted for DTA-15DX, DTA-25DX

**Flange DTA-F10**

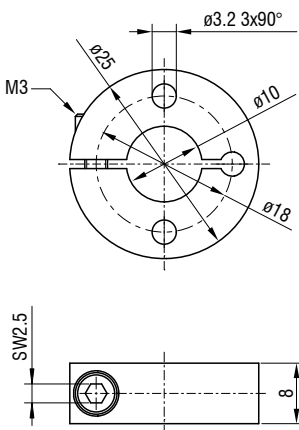



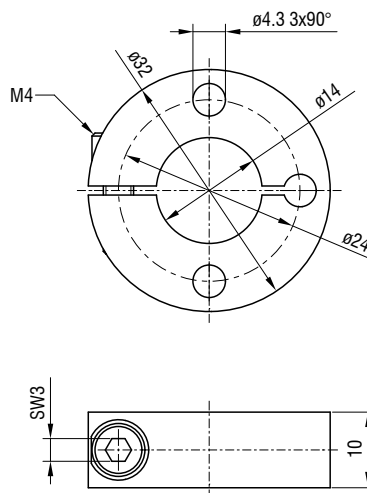

**Flange DTA-F14**





# Linear displacement sensors indu**SENSOR** LDR

-  Operating temperature up to 160 °C
-  Compact design - short installation length
-  High measurement signal quality
-  Robust design IP67
-  Sensor diameter of only  $\varnothing 8$  mm



The specific sensor configuration of the LDR linear displacement sensors is characterized by its short, compact design and small diameter. Only three connections are required as interface to the sensor. Their compact design and the small sensor diameter allow the measuring systems to be installed in confined spaces.

### Fields of application

Low-cost LDR sensors are also particularly suitable for large-scale installation under restricted spatial conditions and in industrial environments with a high measuring rate.

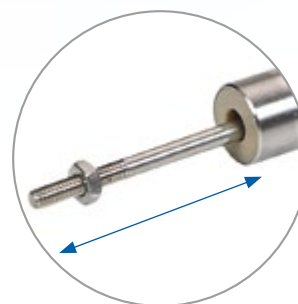

Freely moving plunger

### Article designation

LDR	-10	-CA
	Axial connections CA integral cable (2m) SA plug-in connection	
	Measuring range in mm	
Principle: half-bridge sensor		



Model		LDR-10	LDR-25	LDR-50
Series		SA, CA	SA, CA	SA, CA
Measuring range		10 mm	25 mm	50 mm
Linearity	typ.	$\leq \pm 30 \mu\text{m}$	$\leq \pm 88 \mu\text{m}$	$\leq \pm 250 \mu\text{m}$
	max.	$\leq \pm 50 \mu\text{m}$	$\leq \pm 125 \mu\text{m}$	$\leq \pm 375 \mu\text{m}$
Temperature stability	Zero	$\leq 30 \text{ ppm FSO/K}$	$\leq 30 \text{ ppm FSO/K}$	$\leq 80 \text{ ppm FSO/K}$
	Max. temp. error	$\leq 100 \text{ ppm FSO/K}$	$\leq 100 \text{ ppm FSO/K}$	$\leq 150 \text{ ppm FSO/K}$
Sensitivity		51 mV / mm/V	21 mV / mm/V	5.5 mV / mm/V
Excitation frequency		21 kHz	13 kHz	9 kHz
Excitation voltage		550 mV		
Connection	CA	integrated cable (2 m) with open ends; axial cable outlet; cable diameter 1.8 mm; min. bending radius 10 mm (fixed installation)		
	SA	3-pin connector; axial output (see accessories for connection cable)		
Temperature range <sup>[1]</sup>	Storage	SA: -40 ... +80 °C; CA: -40 ... +160 °C		
	Operation	SA: -15 ... +80 °C; CA: -40 ... +160 °C		
Pressure resistance		Atmospheric pressure		
Shock (DIN EN 60068-2-27)		40 g / 6 ms in 3 axes, 1000 shocks each 100 g / 6 ms in 3 axes, 3 shocks each		
Vibration (DIN EN 60068-2-6)		$\pm 1.5 \text{ mm} / 10 \dots 58 \text{ Hz}$ in 2 axes, 10 cycles each $\pm 20 \text{ g} / 58 \dots 500 \text{ Hz}$ in 2 axes, 10 cycles each		
Protection class (DIN EN 60529)		IP67 (plugged)		
Material		Stainless steel (housing)		
Weight	Sensor	approx. 9 g (SA); approx. 24 g (CA)	approx. 14 g (SA); approx. 28 g (CA)	approx. 23 g (SA); approx. 37 g (CA)
	Plunger	approx. 1.5 g	approx. 2.2 g	approx. 3.5 g
Compatibility		MSC7401, MSC7802, MSC7602		

<sup>[1]</sup> Determined using the box method (-40 ... +80 °C)

### LDR-x-SA

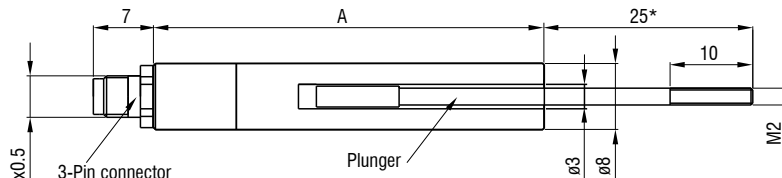

\* Plunger at end of measuring range

Model	A
LDR-10-SA	47 mm
LDR-25-SA	73 mm
LDR-50-SA	127 mm

### LDR-x-CA

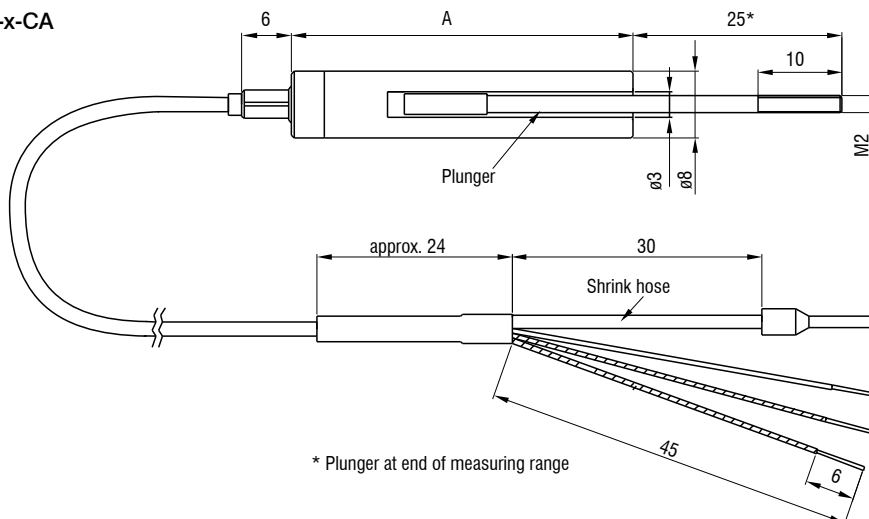

\* Plunger at end of measuring range

Model	A
LDR-10-CA	41 mm
LDR-25-CA	67 mm
LDR-50-CA	121 mm

Dimensions in mm, not to scale

# Mounting options and accessories

## indu**SENSOR** DTA/LDR

### Connection cables

0157047	C7210-5/3	Sensor cable, 5 m, with cable connector
0157048	C7210/90-5/3	Sensor cable, 5 m, with 90° cable connector

### Service (see page 34/35)

Connector assembly M9 and cable reduction XXXX mm - DTA-x  
 Connector assembly M9 - DTA-x (see page 34/35)

### Power supply cable

2901087	PC710-6/4	Supply/output cable, 6 m
---------	-----------	--------------------------

### Spare plungers

0800136	LDR-10	Spare plunger
0800137	LDR-25	Spare plunger
0800138	LDR-50	Spare plunger

### Connector assembly

MBS12/8 Mounting block	Sensor installation for circumferential clamping
MBS12/8 Adapter ring	for reduction to D8 (gauge / LDR)

### Mounting block MBS12/8

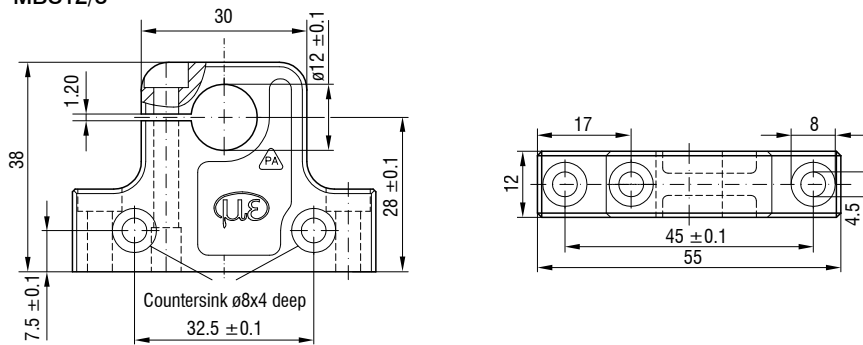

### Adapter ring

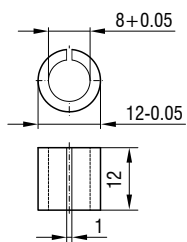

# Applications

## induSENSOR DTA/LDR



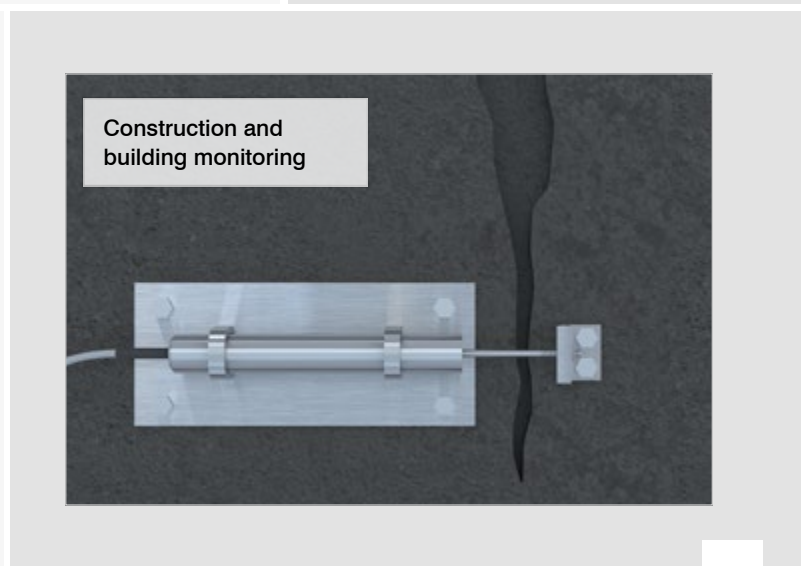
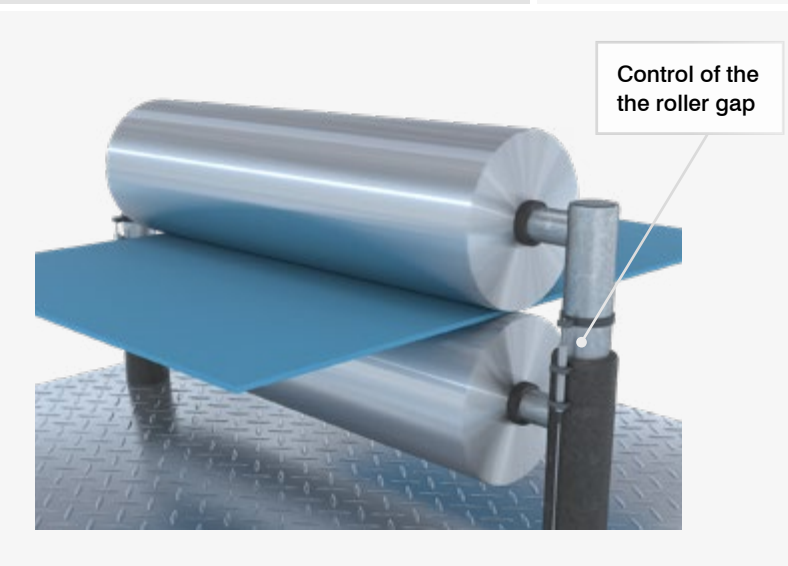
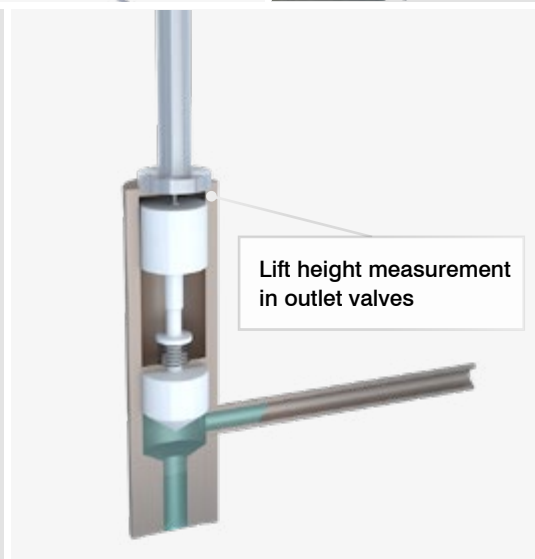
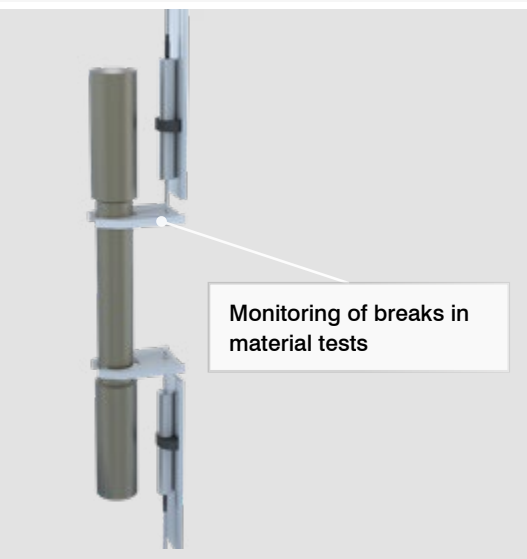
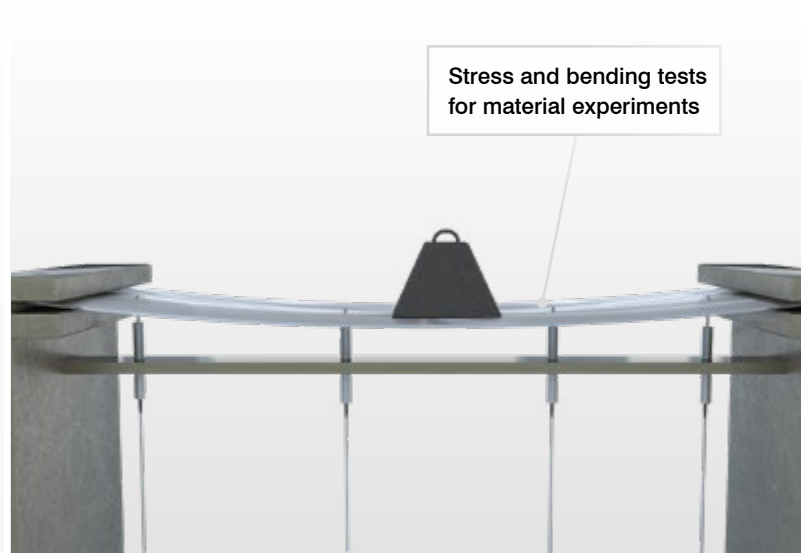
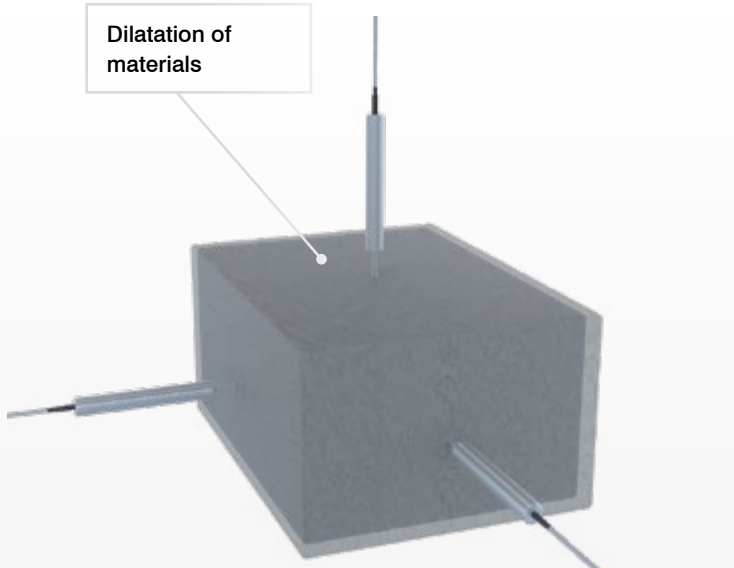

The DTA / LDR displacement sensors are suitable for numerous measurement tasks which require robust designs and high signal stability. Due to their wear-free design, the DTA / LDR sensors impress with longevity and long-term stability.





# Sensors for displacement measurements of rotating shafts

## induSENSOR LVP/LDR

-  Compact design
-  High ambient temperatures
-  High temperature stability
-  High measurement repeatability
-  Robust design IP67



The LVP-25-Z20 and LDR-14-Z20 sensors are designed for monitoring the clamping position in machine tools.

The cylindrical sensors are integrated into the release device and detect the clamping stroke of the drawbar. The measuring object is a ring which is glued onto the drawbar.

The sensors can be universally used for different types of tools due to their extremely compact sensor design. The sensors provide an analog signal according to the stroke motion of the drawbar when clamping the tool. Consequently, continuous monitoring is possible without the switching point having to be set mechanically.

The miniature sensor controller can either be accommodated at the point of measurement or in the control cabinet. Thanks to their high accuracy, the sensors contribute significantly to meeting the ever increasing requirements for precision and availability of machine tools.

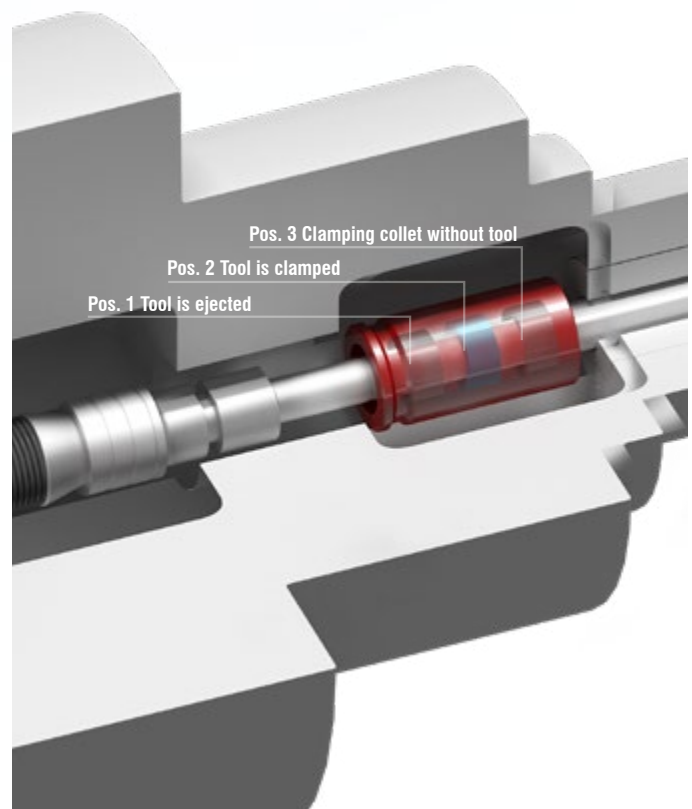

Model		LVP-25-Z20	LDR-14-Z20
Measuring range		25 mm	14 mm
Resolution <sup>[1]</sup>	50 Hz	6 $\mu$ m	7 $\mu$ m
	300 Hz	12 $\mu$ m	14 $\mu$ m
Linearity <sup>[2]</sup>	typ. $\leq \pm 1.5$ % FSO	$\leq \pm 0.375$ mm	$\leq \pm 0.21$ mm
Temperature stability		$\leq 150$ ppm FSO/K	$\leq 200$ ppm FSO/K
Sensitivity <sup>[3]</sup>		16 mV / mm/V	26 mV / mm/V
Excitation frequency		16 KHz	23 KHz
Excitation voltage		550 mV	
Measuring object		Ring for shaft diameter 8 mm or 10 mm (included in delivery)	
Connection		integrated cable 2 m with open ends; axial cable outlet; cable diameter 1.8 mm; min. bending radius 10 mm	
Temperature range	Storage	-40 ... +85 °C	
	Operation <sup>[4]</sup>	-40 ... +120 °C	
Pressure resistance		Atmospheric pressure	
Shock (DIN EN 60068-2-27)		40 g / 5 ms, 6 axes, 1000 shocks each	
Vibration (DIN EN 60068-2-6)		10 Hz - 49.9 Hz: 2 mm; 20 g / 49.9 Hz – 2000 Hz, 3 axes, 10 cycles each	
Protection class (DIN EN 60529)		IP67	
Material		Stainless steel, PEEK	
Weight	Sensor	approx. 40 g	approx. 30 g
	Target ring	< 1 g	< 1 g
Compatibility		MSC7401, MSC7802, MSC7602	

<sup>[1]</sup> Valid when operated with compatible Micro-Epsilon controller

<sup>[2]</sup> Independent linearity

<sup>[3]</sup> With 10 mm reference drawbar

<sup>[4]</sup> Max. temperature change: 3 K / min; higher temperatures on request

### LVP-25-Z20

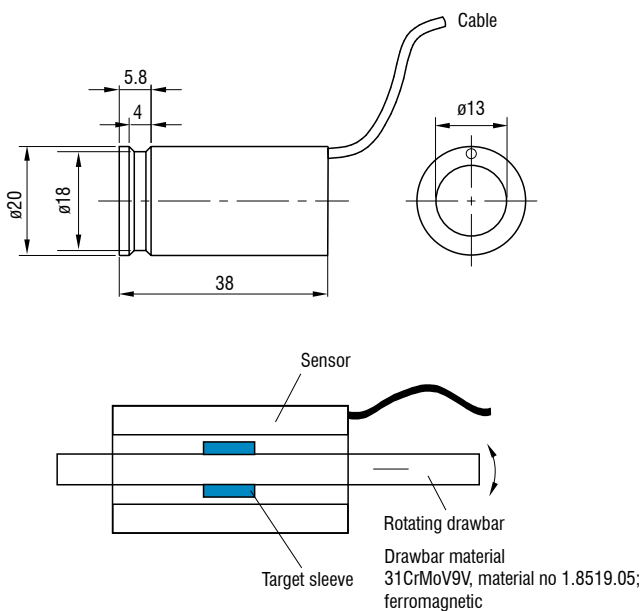

### LDR-14-Z20

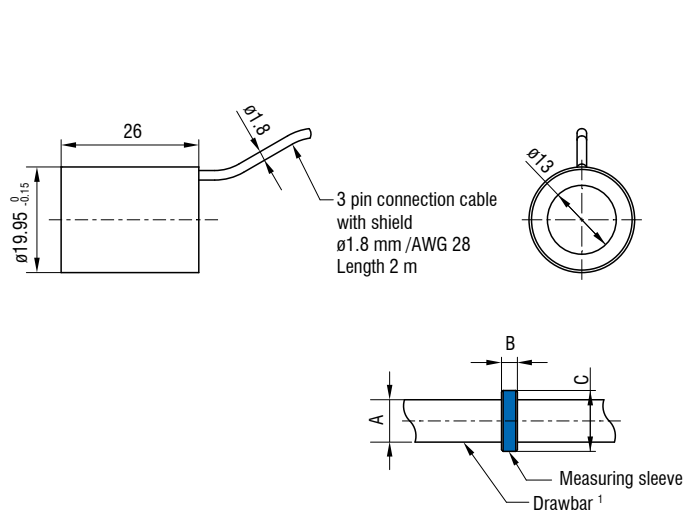







Dimensions in mm, not to scale

		Dimensions		
Model	Drawbar <sup>1</sup>	A	B	C
LVP-25-Z20	D8	ø8 mm	5 mm	ø11.5 mm
	D10	ø10 mm	5.5 mm	ø11.5 mm
LDR-14-Z20	D8	ø8 mm	3 mm	ø11.5 mm
	D10	ø10 mm	5.5 mm	ø11.5 mm

<sup>1)</sup> Not included in delivery

# Compact controller for inductive displacement sensors

## indu**SENSOR** MSC7401 / MSC7802

-  Compact and robust aluminum housing
-  High resolution and linearity
-  Ideal for serial applications in machine building and automation
-  User-friendly parameter setting via buttons or software
-  Models with plug and cable bushings
-  **IP67** Robust design IP67
-  **INTER FACE** Analog (U/I) / RS485 / Ethernet / EtherCAT / PROFINET / EtherNet/IP



The MSC7401 / MSC7802 controllers are designed to be operated with measuring gauges and displacement sensors of the DTA (LVDT) and LDR (half-bridge sensors) series. Due to their robust aluminum housing protected to IP67, the controllers are predestined for industrial measurement tasks.

A wide variety of compatible, inductive displacement sensors and gauges from Micro-Epsilon combined with an optimized price/performance ratio opens up numerous fields of applications in automation technology and machine building. The controller is easily set up using buttons or software. Besides the basic settings, adjusting the measuring systems is also possible. Users can either choose the symmetrical adjustment around the zero point in order to make optimum use of the specific advantages of differential sensors, or teach in two almost arbitrary points within the measuring range. If desired, these settings can be made at the factory and documented with a manufacturer test certificate.

### Example configuration

MSC7401 with DTA-5G8-3-CA gauge:



Technical data	Channel with DTA-5G8-3-CA
Measuring range	± 5 mm
Linearity	30 μm
Resolution	~1.2 μm
Output	Analog and RS485



Model		MSC7401	MSC7802
Resolution <sup>[1]</sup>	DTA series	13 bits (0.012 % FSO) at 50 Hz 12 bits (0.024 % FSO) at 300 Hz	
	LDR series	12 bits (0.024 % FSO) at 50 Hz 11 bits (0.048 % FSO) at 300 Hz	
Frequency response (-3dB)		300 Hz (adjustable only via software)	
Linearity		≤ ±0.02% FSO	
Temperature stability	DTA series	≤ 100 ppm FSO/K	
	LDR series	≤ 125 ppm FSO/K	
Supply voltage <sup>[2]</sup>		14 ... 30 VDC (5 ... 30 VDC)	
Max. current consumption		40 mA	80 mA
Input impedance <sup>[3]</sup>		> 100 kOhm	
Digital interface <sup>[4]</sup>		RS485 / PROFINET / EtherNet/IP / Ethernet / EtherCAT	RS485 / PROFINET / EtherNet/IP
Analog output <sup>[3] [5]</sup>		(0)2 ... 10 V; 0.5 ... 4.5 V; 0 ... 5 V (Ra 1 kOhm) or 0(4) ... 20 mA (load 500 Ohm)	
Connection		Sensor: Screw terminal AWG 16 to AWG 24; with wire end ferrule up to AWG 28 or plug connector 5-pin M9 (see accessories for cable) Supply/signal: Screw terminal AWG 16 to AWG 24; with wire end ferrule up to AWG 28 or plug connector 5-pin M12 (see accessories for cable)	
Mounting		2x mounting holes for M4	
Temperature range	Storage	-40 ... +85 °C	
	Operation	-40 ... +85 °C	
Shock (DIN EN 60068-2-27)		40 g / 6 ms in 3 axes, 2 directions and 1000 shocks each 100 g / 5 ms in 3 axes, 2 directions and 9 shocks each	
Vibration (DIN EN 60068-2-6)		±1.5 mm / 5 ... 57 Hz in 3 axes, 10 cycles each ±20 g / 57 ... 500 Hz in 3 axes, 10 cycles each	
Protection class (DIN EN 60529)		IP67 (plugged)	
Material		Aluminum die casting	
Weight		approx. 200 g	approx. 280 g
Compatibility		full-bridge sensor/LVDT (DTA series) and half-bridge sensor (LDR series)	
No. of measurement channels		1	2

<sup>[1]</sup> Noise: AC RMS measurement via RC low-pass filter of the 1st order with  $f_c = 5$  kHz

<sup>[2]</sup>  $V_+ = 5$  V: no voltage output available; current output: max. load 100  $\Omega$ ;  $V_+ = 9$  V: voltage output: 0.5 V ... 4.5 V or 0 V ... 5 V; current output: max. load 250  $\Omega$

<sup>[3]</sup> Sensor side

<sup>[4]</sup> For PROFINET / EtherNet/IP / Ethernet / EtherCAT: Connection via interface module (see accessories)

<sup>[5]</sup> 0 V  $\triangleq$  < 30 mV, 0 mA  $\triangleq$  < 35  $\mu$ A; for controllers with current output, the output signal is limited to approx. 21 mA



# Dimensions

## induSENSOR MSC7401 / MSC7802

MSC7401

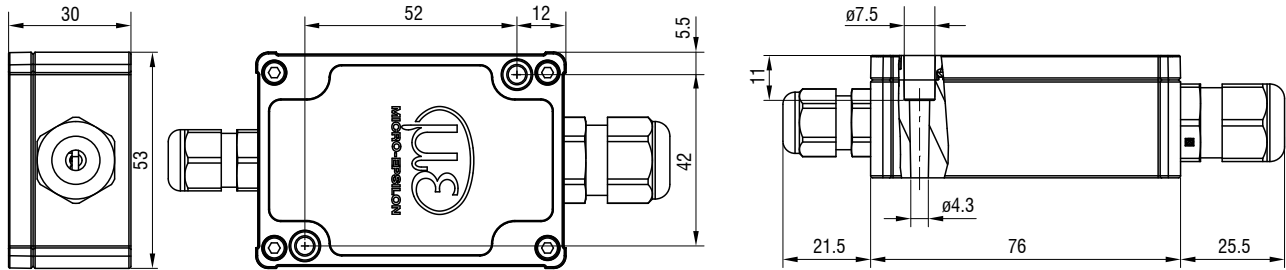

MSC7401 (010)

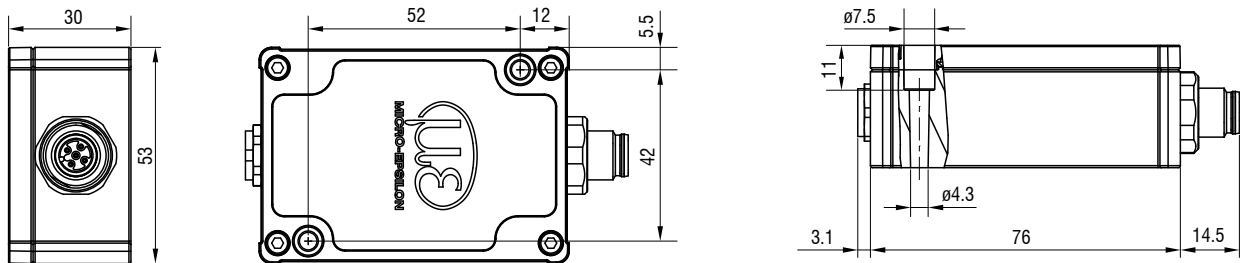

MSC7401 (020)

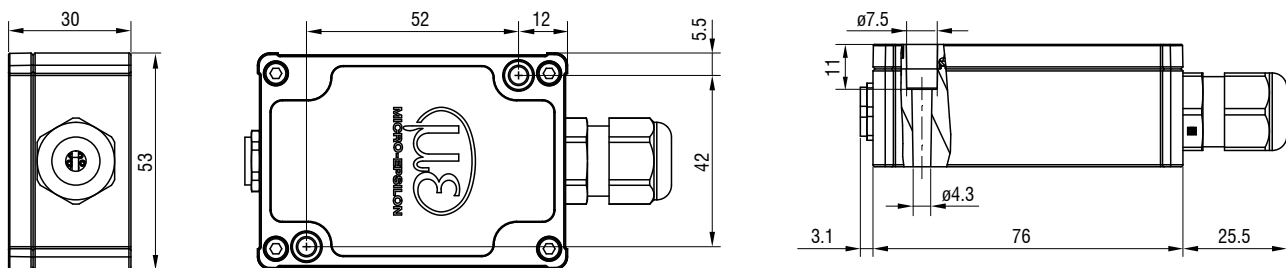

MSC7401 (030)

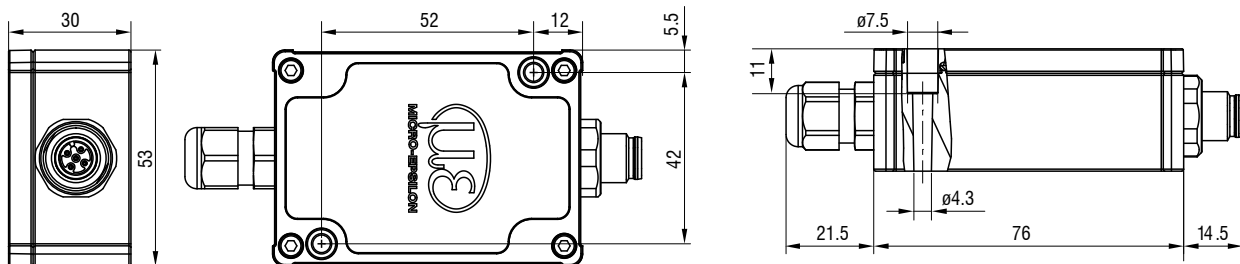

MSC7802

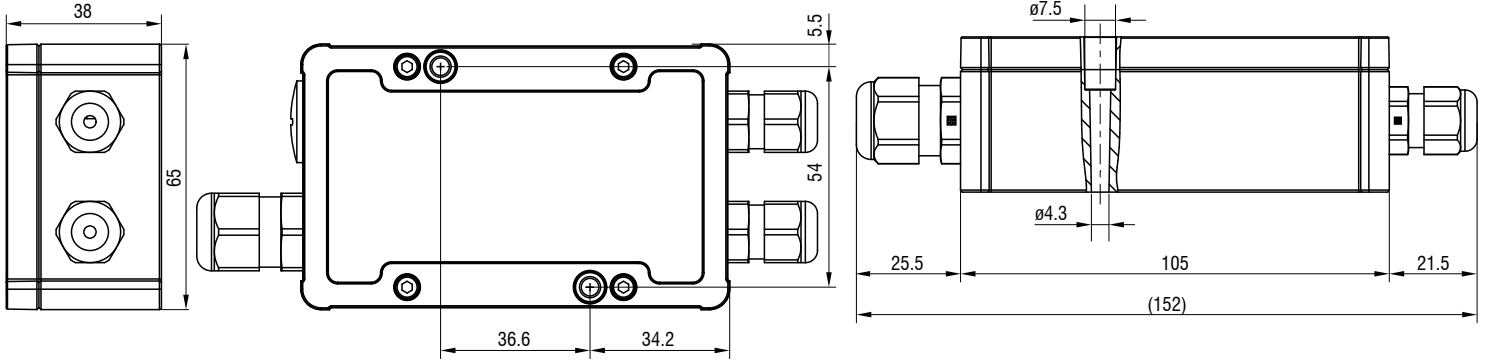

MSC7802(010)

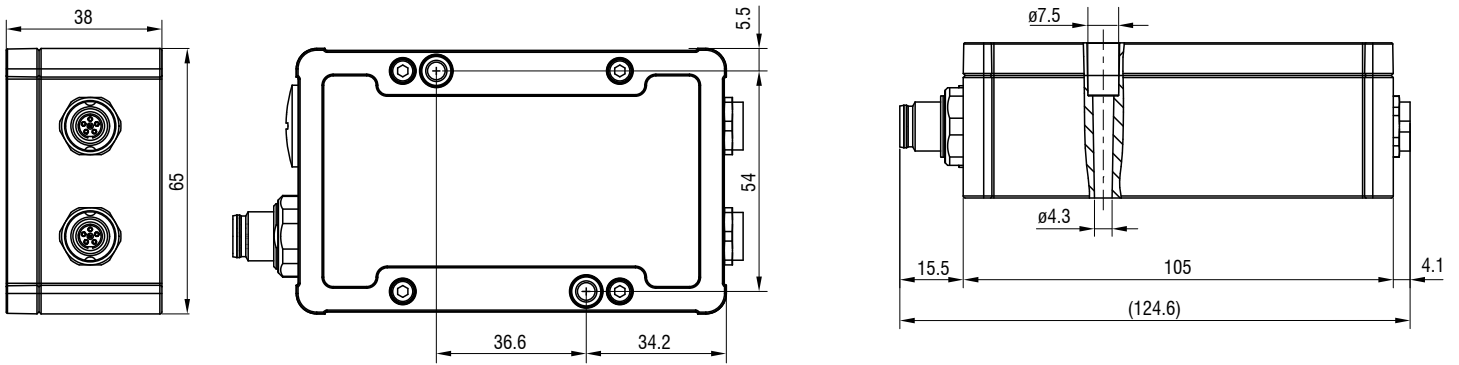

MSC7802(020)

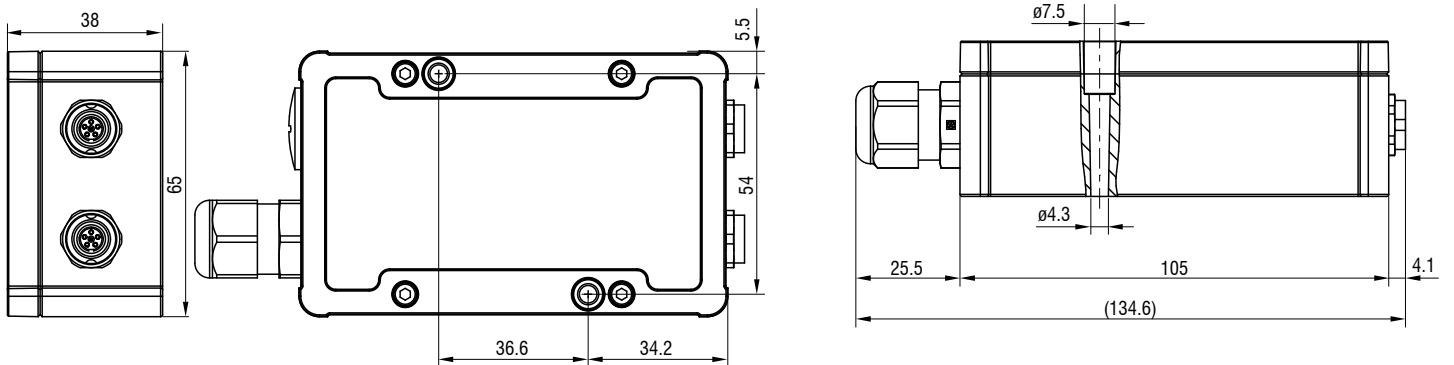



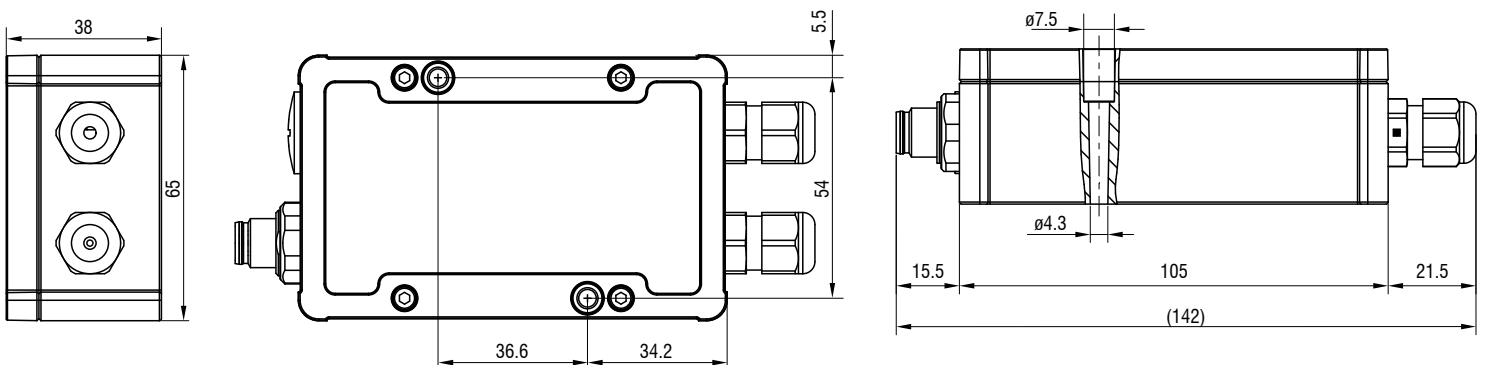

MSC7802(030)



Dimensions in mm, not to scale

# Controller for inductive displacement sensors **induSENSOR MSC7602**

-  Ideal for serial applications in machine building and automation
-  High resolution and linearity
-  User-friendly parameter setting via buttons or software
-  Multi-channel capability & synchronous operation
- INTERFACE** Analog (U/I) / RS485 / PROFINET / EtherNet/IP



The MSC7602 controller is designed to be operated with measuring gauges and displacement sensors of the DTA (LVDT) and LDR (half-bridge sensors) series. A wide variety of compatible, inductive displacement sensors and gauges from Micro-Epsilon combined with an optimized price/performance ratio opens up numerous fields of applications in automation technology and machine building.

The controller is ideally suited to multi-channel applications. The bus connector on the rear side significantly reduces wiring effort. The controller can be easily set up via buttons/LEDs or software.

Users can either choose the symmetrical adjustment around the zero point in order to make optimum use of the specific advantages of differential sensors, or teach in two almost arbitrary points within the measuring range. If desired, these settings can be made at the factory and documented with a manufacturer test certificate.



Easy "click-fit" installation with DIN rail

**Long measurement chains with up to 62 subscribers/bus**



Model		MSC7602
Resolution <sup>[1]</sup>	DTA series	13 bits (0.012 % FSO) at 50 Hz 12 bits (0.024 % FSO) at 300 Hz
	LDR series	12 bits (0.024 % FSO) at 50 Hz 11 bits (0.048 % FSO) at 300 Hz
Frequency response (-3dB)		300 Hz (adjustable only via software)
Linearity		≤ ±0.02% FSO
Temperature stability	DTA series	≤ 100 ppm FSO/K
	LDR series	≤ 125 ppm FSO/K
Supply voltage <sup>[2]</sup>		14 ... 30 VDC (5 ... 30 VDC)
Max. current consumption		80 mA
Input impedance <sup>[3]</sup>		> 100 kOhm
Digital interface <sup>[4]</sup>		RS485 / PROFINET / EtherNet/IP
Analog output <sup>[5]</sup>		(0)2 ... 10 V; 0.5 ... 4.5 V; 0 ... 5 V (Ra 1 kOhm) or 0(4) ... 20 mA (load 500 Ohm)
Connection		Sensor: Screw terminal AWG 16 to AWG 28 Supply/signal: Screw terminal AWG 16 to AWG 28 Supply/sync/RS485: DIN rail bus connector
Mounting		DIN rail 35 mm
Temperature range	Storage	-40 ... +85 °C
	Operation	-40 ... +85 °C
Shock (DIN EN 60068-2-27)		5 g / 6 ms in 6 axes, 1000 shocks each 15 g / 11 ms in 6 axes, 10 shocks
Vibration (DIN EN 60068-2-6)		±2 mm / 10 ... 15.77 Hz in 3 axes, 10 cycles each ±2 g / 15.77 ... 2000 Hz in 3 axes, 10 cycles each
Protection class (DIN EN 60529)		IP20
Material		Polyamide
Weight		approx. 120 g
Compatibility		full-bridge sensor/LVDT (DTA series) and half-bridge sensor (LDR series)
No. of measurement channels		2

<sup>[1]</sup> Noise: AC RMS measurement via RC low-pass filter of the 1st order with  $f_c = 5$  kHz

<sup>[2]</sup>  $V_+ = 5$  V: no voltage output available; current output: max. load 100  $\Omega$ ;  $V_+ = 9$  V: voltage output: 0.5 V ... 4.5 V or 0 V ... 5 V; current output: max. load 250  $\Omega$

<sup>[3]</sup> Sensor side

<sup>[4]</sup> For PROFINET / EtherNet/IP / Ethernet / EtherCAT: Connection via interface module (see accessories)

<sup>[5]</sup> 0 V ≤ < 30 mV, 0 mA ≤ < 35  $\mu$ A; for controllers with current output, the output signal is limited to approx. 21 mA

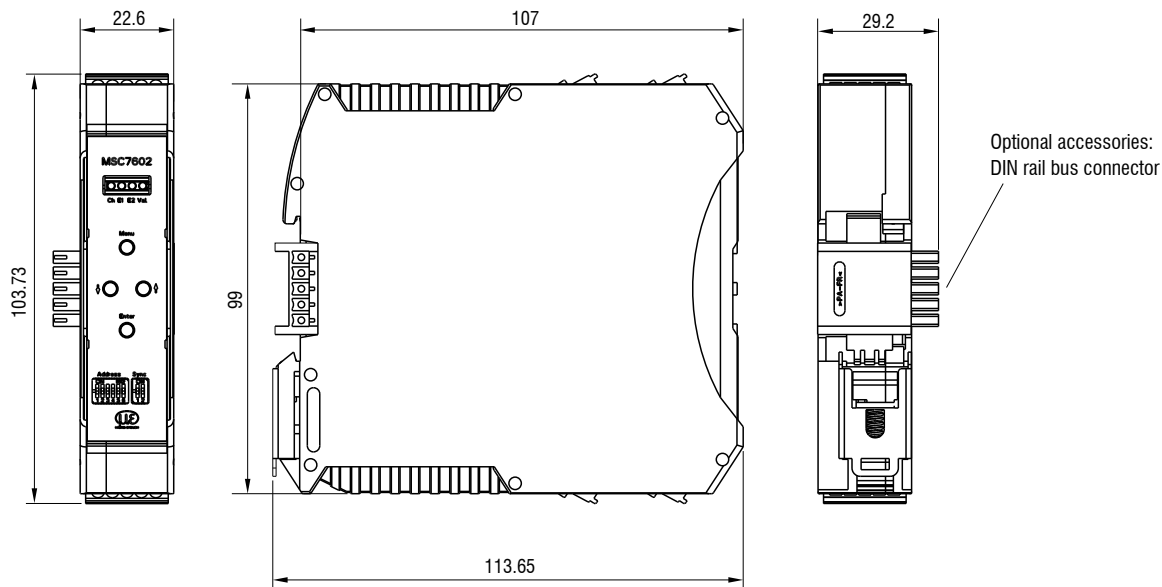

Dimensions in mm, not to scale

# Accessories and connection possibilities

## induSENSOR MSC

### Accessories for MSC7401 / MSC7602 / MSC7802

#### Connection cables

- PC7400-6/4 Supply and output cable, 6 m
- PC5/5-IWT Supply and output cable, 5 m (only MSC7401 / MSC7802)
- IF7001 Single-channel USB/RS485 converter for MSC7xxx
- MSC7602 connector kit



MSC7602 connector kit

#### Service

Connection, adjustment and calibration including manufacturer certificate

#### Interface modules

- IF2035-EIP DIN rail interface module for Ethernet/IP (multi-channel)
- IF2035-PROFINET DIN rail interface module for PROFINET (multi-channel)
- IF2035-EtherCAT DIN rail interface module for EtherCAT (multi-channel)
- IF1032/ETH Interface module for Ethernet/EtherCAT (single channel) (only MSC7401 / MSC7802)

#### Power supply units

- PS2401/100-240/24V/1A Universal power supply unit with open ends

### Connection options MSC7401

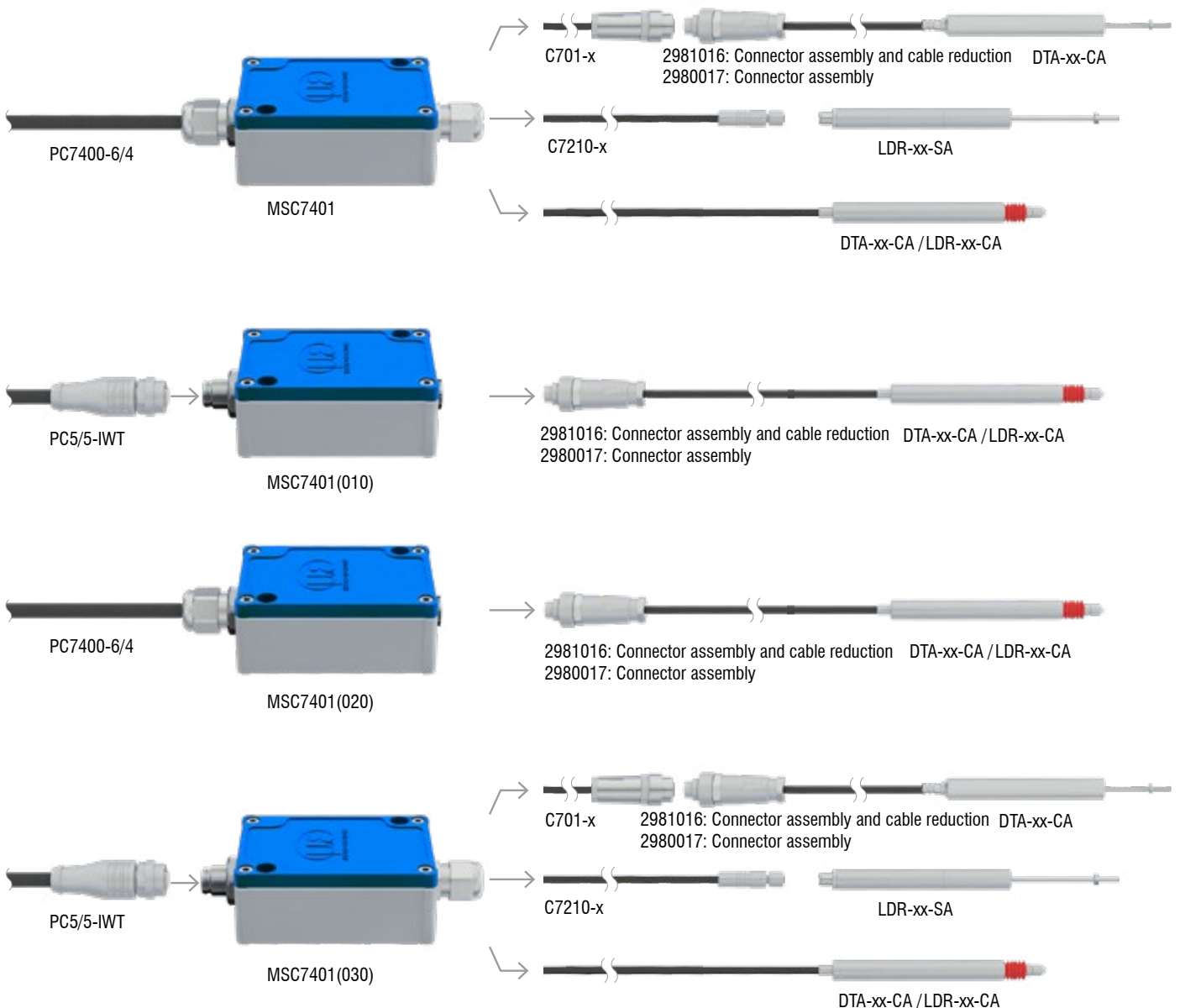





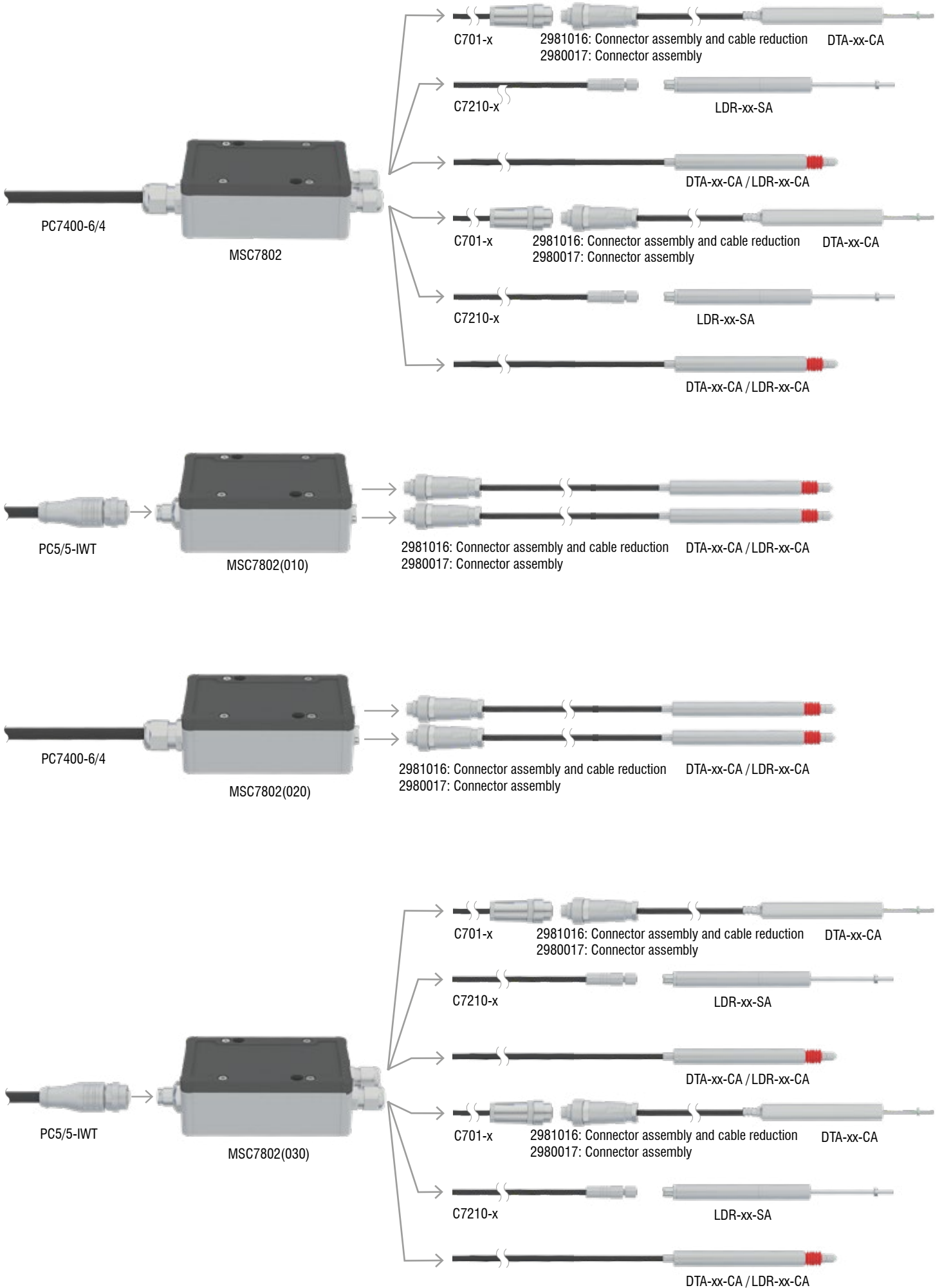

Connection options MSC7802



# Robust long-stroke sensors for hydraulics & pneumatics

## induSENSOR EDS

-  Measuring ranges from 75 ... 630 mm
-  Linearity  $\pm 0.3\%$  FSO
-  Integrated controller
-  High resistance to pressure and oil, maintenance free
-  Short offset ranges



induSENSOR EDS long-stroke sensors are designed for industrial use in hydraulic and pneumatic cylinders for displacement and position measurements of pistons or valves, e.g., to measure

- displacement, position, gap
- deflection
- movement, stroke
- filling level, immersion depth and spring travel

The sensor elements of the EDS series are protected by a pressure resistant stainless steel housing. The sensor controller and signal processing are completely integrated in a sensor flange.

An aluminum tube is used as target, which is guided over the sensor rod in a non-contact and wear-free manner. Due to their robust, constructional design, the EDS long-stroke sensors have proven invaluable for integration into hydraulic and pneumatic cylinders and for position monitoring in harsh industrial environments. Due to the eddy current principle applied, no permanent magnets need to be mounted inside the cylinder.

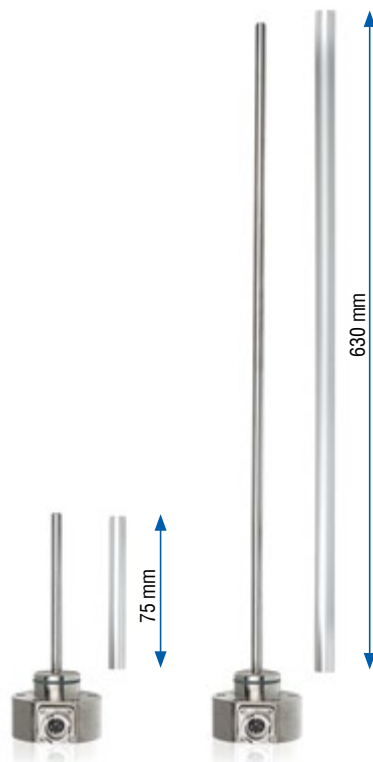

induSENSOR EDS sensors impress with an optimal ratio of compact design and large measuring range. Due to their small offset, the measuring range starts very close to the flange.



Model	EDS-	75 mm	100 mm	160 mm	200 mm	250 mm	300 mm	400 mm	500 mm	630 mm
Series		S	S, F	S, F	S, F	S, F	S, F	S, F	S	S, F
Measuring range		75 mm	100 mm	160 mm	200 mm	250 mm	300 mm	400 mm	500 mm	630 mm
Resolution		0.038 mm	0.05 mm	0.08 mm	0.1 mm	0.125 mm	0.15 mm	0.2 mm	0.25 mm	0.315 mm
Frequency response (-3dB)		150 Hz								
Measuring rate		600 Sa/s								500 Sa/s
Linearity	≤ ±0.3 % FSO	≤ ±0.23 mm	≤ ±0.3 mm	≤ ±0.48 mm	≤ ±0.6 mm	≤ ±0.75 mm	≤ ±0.9 mm	≤ ±1.2 mm	≤ ±1.5 mm	≤ ±1.89 mm
Temperature stability		≤ 200 ppm FSO/K								
Supply voltage		18 ... 30 VDC								
Max. current consumption		40 mA								
Analog output <sup>[1]</sup>		4 ... 20 mA (load 500 Ohm)								
Connection	S series	7-pin M9 screw/plug connection (Binder); axial, radial on request (see accessories for connection cable)								
	F series	5-pin bayonet screw plug connection; radial output (see accessories for connection cable)								
Temperature range	Storage	-40 ... +100 °C								
	Operation	-40 ... +85 °C								
Pressure resistance		450 bar (front)								
Shock (DIN EN 60068-2-27)		40 g / 6 ms in 3 axes, 1000 shocks each 100 g / 6 ms radial, 3 shocks each 300 g / 6 ms axial, 3 shocks each								
Vibration (DIN EN 60068-2-6)		±2.5 mm / 5 ... 44 Hz, 10 cycles each ±23 g / 44 ... 500 Hz, 10 cycles each								
Protection class (DIN EN 60529) <sup>[2]</sup>		IP65 (F series) / IP67 (S series)								
Material		Stainless steel (housing); aluminum (measuring tube)								

<sup>[1]</sup> Optional voltage output (1 ... 5 V) with connection cable C703-5/U for EDS, S series

<sup>[2]</sup> Models with plug connection only with suitable and connected mating plug

### Model S

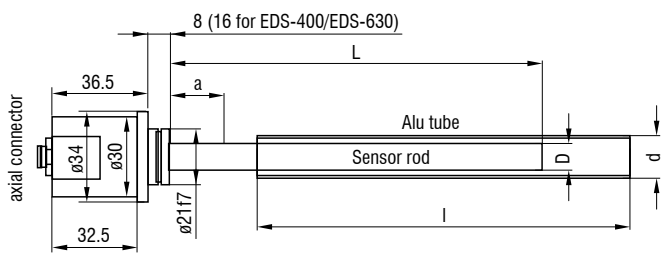

### Model F

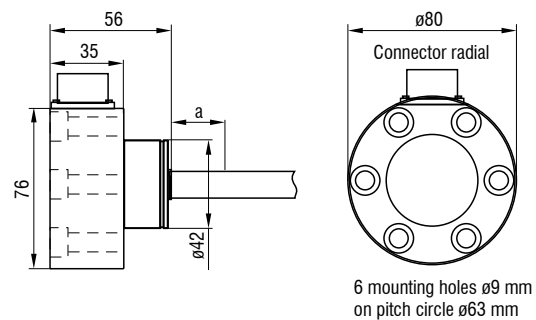

### Article designation

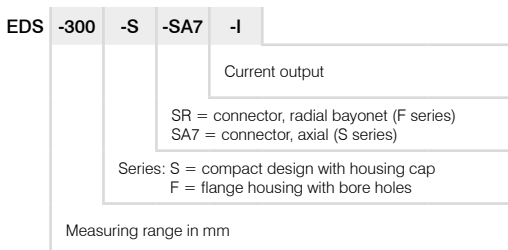

Measuring ranges	Sensor rod		Aluminum tube				Offset
	L	D	l	d	a		
75	110	10	110	16	15		
100	140	10	140	16	20		
160	200	10	200	16	20		
200	240	10	240	16	20		
250	290	10	290	16	20		
300	340	10	340	16	20		
400	450	12	450 (S) 460 (F)	18 (S) 26 (F)	25		
500	550	12	550	18	25		
630	680	12	680 (S) 690 (F)	18 (S) 26 (F)	25		

# Mounting options and accessories

## indu**SENSOR** EDS

### Accessories for S series

#### Connection cables

C703-5 EDS connection cable for S series, 7-pin, length 5 m

C703-5/U EDS connection cable for S series, 7-pin, length 5 m, for voltage output 1 - 5 V

C703/90-5 EDS connection cable for S series, 7-pin, length 5 m with 90° angled cable connector

Mating plug, S series

#### Spare tubes

Measuring tube for EDS-75-S	Spare tube
Measuring tube for EDS-100-S	Spare tube
Measuring tube for EDS-160-S	Spare tube
Measuring tube for EDS-200-S	Spare tube
Measuring tube for EDS-250-S	Spare tube
Measuring tube for EDS-300-S	Spare tube
Measuring tube for EDS-400-F	Spare tube
Measuring tube for EDS-630-F	Spare tube

#### Mounting ring

0483326 EDS mounting ring

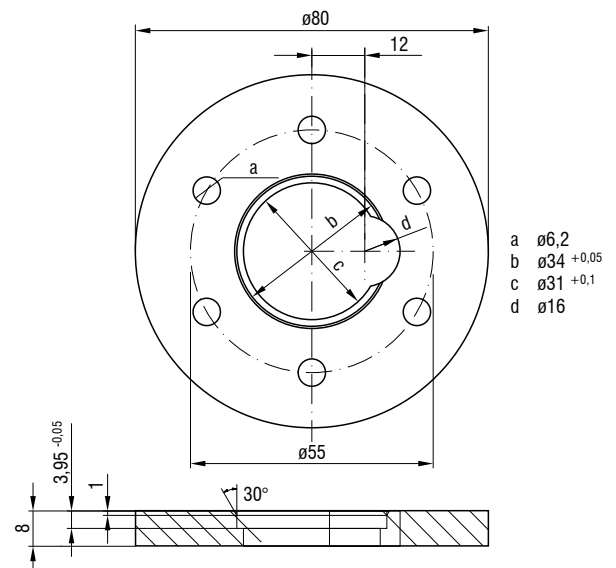

### Accessories for the F series

#### Connection cables

C705-5 EDS connection cable for F series, 5-pin, length 5 m

C705-15 EDS connection cable for F series, 5-pin, length 15 m

EDS connector kit, F series

#### Spare tubes

Measuring tube for EDS-100-F	Spare tube
Measuring tube for EDS-160-F	Spare tube
Measuring tube for EDS-200-F	Spare tube
Measuring tube for EDS-250-F	Spare tube
Measuring tube for EDS-300-F	Spare tube
Measuring tube for EDS-400-F	Spare tube
Measuring tube for EDS-630-F	Spare tube



EDS-F: Measuring the grinding gap in crushers



EDS-S: Lift height measurement in pneumatic cylinders; flange outside the cylinder



EDS-Z: Integration in hydraulic cylinders; integrated flange and M12 built-in plug



# Technology and measuring principle

## induSENSOR

### LVDT Gauges and LVDT displacement sensors (DTA series)

LVDT displacement sensors and gauges (Linear Variable Differential Transformer) are constructed with a primary and two secondary coils, which are arranged symmetrically to the primary winding. As a measuring object, a rod shaped soft-magnetic core can be moved within the differential transformer. An electronic oscillator supplies the primary coil with an alternating current of constant frequency. The excitation is an alternating voltage with an amplitude of a few volts and a frequency between 1 and 10 kHz.

Depending on the core position, alternating voltages are induced in the two secondary windings. If the core is located in its "zero position", the coupling of the primary to both secondary coils is equally large. Movement of the core within the magnetic field of the coil causes a higher voltage in one secondary coil and a lower voltage in the second coil. The difference between the two secondary voltages is proportional to the core displacement. Due to the differential design of the sensor, the LVDT series has an output signal which is very stable.

Signal LVDT sensor

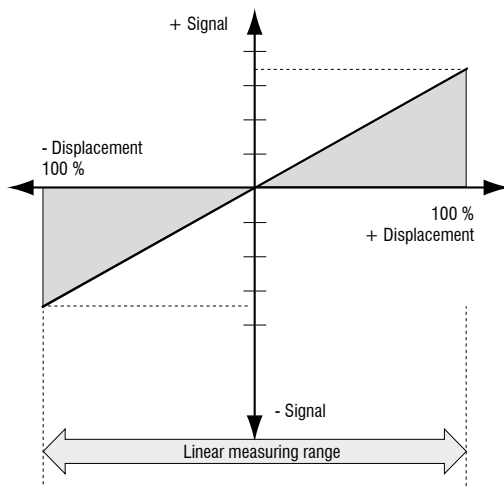

Measuring principle gauging sensor

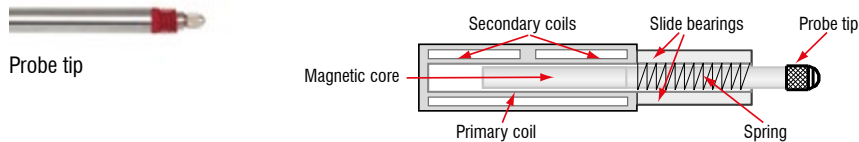

Measuring principle displacement sensor

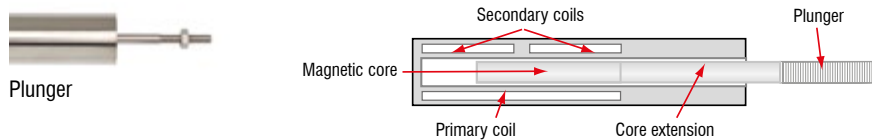

### LDR Displacement sensors

The inductive sensors in the LDR series are constructed as half-bridge systems with center tap. An unguided plunger moves in the interior of the sensor coil, which consists of symmetrically constructed winding compartments. The plunger is joined to the moving measuring object via a thread.

Due to the movement of the plunger within the coil, an electrical signal is produced which is proportional to the displacement covered. The specific sensor configuration facilitates a short, compact design with a small diameter. Three connections are required as an interface to the sensor.

#### Block diagram LDR series

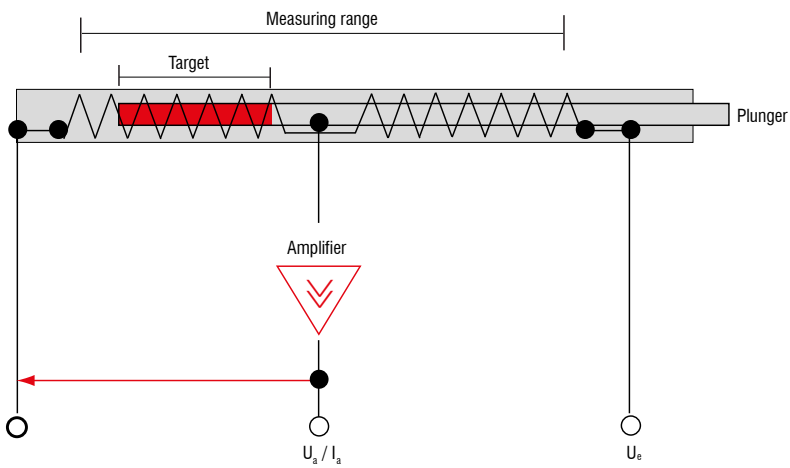

# Technology and measuring principle

## induSENSOR

### Independent and absolute linearity of LVDT sensors

Please consider that with LVDT sensors, two kinds of linearity must be distinguished:

With the independent linearity, an individual linearity characteristic is determined for the recorded sensor signal of each sensor. It describes the deviation of the recorded sensor signal from the individually calculated reference line (red, see figure). The maximum deviation ( $d$ ) must not exceed the values specified in the datasheet.

With the absolute linearity, a new straight line is laid through two fixed points during the adjustment which may cause the gradient of the reference line to change. Therefore, the recorded values of the sensor signal may deviate more from the new line (blue) than is the case with the independent linearity (see figure), and also exceed the values specified in the datasheet.

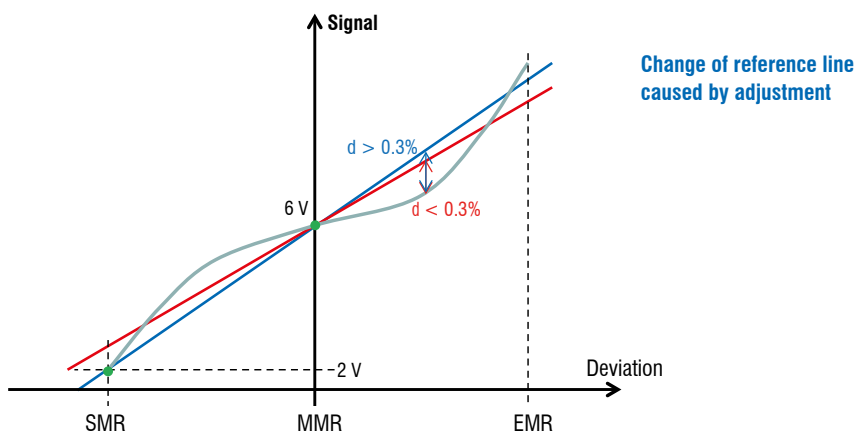
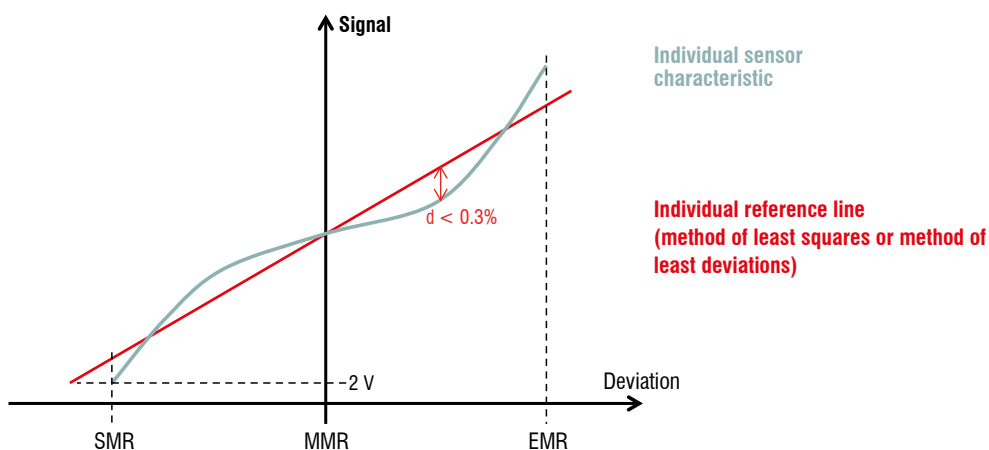

### EDS Long-stroke sensors

The measuring principle of the EDS series is based on the eddy current effect. The displacement transducer consists of a measurement coil and a compensation coil which are integrated into a pressurized sensor rod composed of stainless, non-ferromagnetic material. An aluminum tube which can be moved along the housing without making contact is used as the target.

If both coils are supplied with an alternating current, then two orthogonal magnetic fields are produced in the sleeve. The field produced from the single-layer measuring coil has a magnetic coupling with the tube. Therefore, the eddy currents produced in the tube form a magnetic field, which influences the impedance of the measuring coil. This changes linearly with the target position. The magnetic field of the compensation coil has in contrast no coupling with the target and the impedance of the compensation coil is largely independent of the target position.

The electronic circuit generates a signal from the ratio of the impedance of the measurement coil and the compensation coil and converts the sleeve position into a linear electrical output signal of 4 - 20 mA. This significantly eliminates the effects of temperature.

Block diagram EDS series

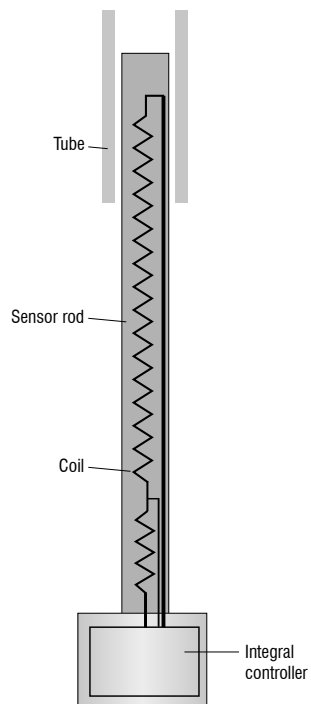

## Sensors and Systems from Micro-Epsilon



Sensors and systems for displacement, position and dimension



Sensors and measurement devices for non-contact temperature measurement



Measuring and inspection systems for quality assurance



Optical micrometers, fiber optics, measuring and test amplifiers



Color recognition sensors, LED Analyzers and inline color spectrometers

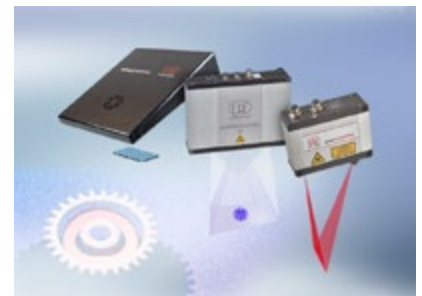

3D measurement technology for dimensional testing and surface inspection