



Operating Instructions **optoNCDT 1900**

ILD1900-2
ILD1900-6
ILD1900-10
ILD1900-25
ILD1900-50

ILD1900-100
ILD1900-200
ILD1900-500

ILD1900-2LL
ILD1900-6LL
ILD1900-10LL
ILD1900-25LL
ILD1900-50LL

ILD1910-500
ILD1910-750

Intelligent laser optical displacement measurement

MICRO-EPSILON
MESSTECHNIK
GmbH & Co. KG
Koenigbacher Str. 15

94496 Ortenburg / Germany

Tel. +49 (0) 8542 / 168-0
Fax +49 (0) 8542 / 168-90
e-mail info@micro-epsilon.com
www.micro-epsilon.com

Contents

| | | |
|-----------|---|-----------|
| 1. | Safety | 9 |
| 1.1 | Symbols Used | 9 |
| 1.2 | Warnings | 9 |
| 1.3 | Notes on Product Marking..... | 10 |
| | 1.3.1 CE Marking | 10 |
| | 1.3.2 UKCA Marking | 10 |
| | 1.3.3 NRTL TÜV SÜD mark | 10 |
| 1.4 | Intended Use | 11 |
| 1.5 | Proper Environment..... | 11 |
| 2. | Laser Safety | 12 |
| 2.1 | General | 12 |
| 2.2 | Laser Class 2 | 12 |
| 2.3 | Laser Class 3R | 14 |
| 3. | Functional Principle, Technical Data | 16 |
| 3.1 | Short Description | 16 |
| 3.2 | Advanced Surface Compensation | 17 |
| 3.3 | Technical Data ILD1900-xx | 18 |
| 3.4 | Technical Data ILD1900-xxLL | 20 |
| 3.5 | Technical Data ILD1910 | 22 |
| 4. | Delivery | 24 |
| 4.1 | Unpacking, Included in Delivery..... | 24 |
| 4.2 | Storage | 24 |
| 5. | Installation | 25 |
| 5.1 | Instructions for Installation | 25 |
| | 5.1.1 Reflection Factor of the Target Surface | 25 |
| | 5.1.2 Error Influences | 26 |
| | 5.1.2.1 Light from Other Sources | 26 |
| | 5.1.2.2 Color Differences | 26 |
| | 5.1.2.3 Temperature Influences | 26 |
| | 5.1.2.4 Mechanical Vibration | 26 |
| | 5.1.2.5 Movement Blurs | 26 |
| | 5.1.2.6 Surface Roughness | 27 |
| | 5.1.2.7 Angle Influences | 28 |

| | | | |
|-----------|-------|--|-----------|
| | 5.1.3 | Optimizing the Measuring Accuracy | 29 |
| 5.2 | | Mounting | 30 |
| | 5.2.1 | General | 30 |
| | 5.2.2 | Attachment, Dimensions ILD1900..... | 30 |
| | 5.2.3 | Attachment, Dimensions ILD1910..... | 32 |
| 5.3 | | Indicator Elements at Sensor | 33 |
| 5.4 | | Electrical Connections..... | 34 |
| | 5.4.1 | Connection Possibilities | 34 |
| | 5.4.2 | Pin Assignment..... | 36 |
| | 5.4.3 | Supply Voltage | 37 |
| | 5.4.4 | Laser On | 38 |
| | 5.4.5 | Analog Output | 39 |
| | 5.4.6 | Multifunction Input | 40 |
| | 5.4.7 | RS422 Connection with USB Converter IF2001/USB | 41 |
| | 5.4.8 | Switching Output..... | 42 |
| | 5.4.9 | Connector and Sensor Cable..... | 43 |
| 6. | | Operation | 44 |
| 6.1 | | Getting Ready for Operation | 44 |
| 6.2 | | Operation via Web Interface | 45 |
| | 6.2.1 | Preconditions..... | 45 |
| | 6.2.2 | Access via Web Interface | 46 |
| 6.3 | | Presets, Setups, Measurement Configuration | 48 |
| 6.4 | | Measurement Presentation via Web Browser | 51 |
| 6.5 | | Video Signal via Web Browser | 53 |
| 6.6 | | Parametrization via ASCII Commands | 55 |
| 6.7 | | Timing, Measurement Value Flux | 55 |
| 6.8 | | Menu Structure, Operation via Membrane Keys..... | 56 |
| 7. | | Setting Sensor Parameters..... | 58 |
| 7.1 | | Preliminary Remarks about the Setting Possibilities..... | 58 |
| 7.2 | | Overview Parameter..... | 58 |
| 7.3 | | Inputs | 59 |
| | 7.3.1 | Synchronization via Sync +/- Connections | 60 |
| | 7.3.2 | Synchronization via Multi-Function Input..... | 62 |
| 7.4 | | Data Recording..... | 63 |
| | 7.4.1 | Preliminary Remark | 63 |
| | 7.4.2 | Measurement Configuration..... | 63 |
| | 7.4.3 | Measuring Rate | 63 |

| | | | |
|-----|-------|--|----|
| | 7.4.4 | Triggering..... | 64 |
| | | 7.4.4.1 General..... | 64 |
| | | 7.4.4.2 Triggering Data Recording | 66 |
| | | 7.4.4.3 Triggering Data Output | 66 |
| | 7.4.5 | Masking the Evaluation Range, ROI | 67 |
| | 7.4.6 | Exposure Mode | 68 |
| | 7.4.7 | Peak Selection..... | 69 |
| | 7.4.8 | Error Processing..... | 69 |
| 7.5 | | Signal Processing..... | 70 |
| | 7.5.1 | Preliminary Remark | 70 |
| | 7.5.2 | Averaging..... | 70 |
| | | 7.5.2.1 General..... | 70 |
| | | 7.5.2.2 Moving Average | 71 |
| | | 7.5.2.3 Recursive Average | 72 |
| | | 7.5.2.4 Median | 72 |
| | 7.5.3 | Zeroing and Mastering | 73 |
| | | 7.5.3.1 Zeroing, Mastering with Select Key | 74 |
| | | 7.5.3.2 Zeroing, Mastering with Hardware Input | 75 |
| | 7.5.4 | Output Trigger | 76 |
| | 7.5.5 | Data Reduction, Output Data Rate..... | 76 |
| 7.6 | | Outputs | 77 |
| | 7.6.1 | Overview | 77 |
| | 7.6.2 | Digital Output, RS422..... | 79 |
| | | 7.6.2.1 Values, Ranges | 79 |
| | | 7.6.2.2 Behavior of the Digital Output..... | 81 |
| | 7.6.3 | Analog Output | 83 |
| | | 7.6.3.1 Output Scaling | 83 |
| | | 7.6.3.2 Output Scaling with the Select Button..... | 84 |
| | | 7.6.3.3 Output Scaling via Hardware Input | 85 |
| | | 7.6.3.4 Calculation of the Measurement Value at the Current Output | 86 |
| | | 7.6.3.5 Calculation of the Measurement Value from the Voltage Output | 87 |
| | 7.6.4 | Switching Outputs | 88 |
| | 7.6.5 | Data Output | 89 |

| | | |
|-----------------|--|------------|
| 7.7 | System Settings | 90 |
| 7.7.1 | General | 90 |
| 7.7.2 | Unit, Language | 90 |
| 7.7.3 | Key Lock | 90 |
| 7.7.4 | Load and Save | 91 |
| 7.7.5 | Import, Export | 93 |
| 7.7.6 | Access Authorization | 94 |
| 7.7.7 | Reset Sensor | 95 |
| 8. | Digital Interfaces RS422 | 96 |
| 8.1 | Preliminary Remarks | 96 |
| 8.2 | Measurement Data Format | 96 |
| 8.3 | Conversion of the Binary Data Format | 97 |
| 9. | Cleaning | 98 |
| 10. | Software Support with MEDAQLib | 98 |
| 11. | Disclaimer | 99 |
| 12. | Service, Repair | 99 |
| 13. | Decommissioning, Disposal | 100 |
| Appendix | | |
| A 1 | Optional Accessories | 101 |
| A 2 | Factory Setting | 104 |
| A 3 | ASCII Communication with Sensor | 105 |
| A 3.1 | General | 105 |
| A 3.2 | Overview Commands | 107 |
| A 3.2.1 | General Commands | 110 |
| A 3.2.1.1 | HELP | 110 |
| A 3.2.1.2 | GETINFO, Sensor Information | 112 |
| A 3.2.1.3 | LANGUAGE Web Interface | 112 |
| A 3.2.1.4 | RESET, Boot Sensor | 113 |
| A 3.2.1.5 | RESETCNT, Reset Counter | 113 |
| A 3.2.1.6 | ECHO, Switching the Command Reply, ASCII Interface | 113 |
| A 3.2.1.7 | PRINT, Sensor Settings | 114 |
| A 3.2.1.8 | SYNC | 115 |
| A 3.2.1.9 | TERMINATION | 115 |

| | | |
|-----------|---|-----|
| A 3.2.2 | User Level | 116 |
| A 3.2.2.1 | LOGIN, Change of the User Level | 116 |
| A 3.2.2.2 | LOGOUT, Change into User Level | 116 |
| A 3.2.2.3 | GETUSERLEVEL, User Level Request | 116 |
| A 3.2.2.4 | STDUSER, Set Standard User | 116 |
| A 3.2.2.5 | PASSWD, Change Password | 116 |
| A 3.2.3 | Triggering | 117 |
| A 3.2.3.1 | TRIGGERLEVEL, Active Level Triggering | 117 |
| A 3.2.3.2 | TRIGGERMODE | 117 |
| A 3.2.3.3 | TRIGGERSOURCE, Trigger Source | 117 |
| A 3.2.3.4 | TRIGGERAT, Effect of the Trigger Input | 117 |
| A 3.2.3.5 | MFILEVEL, Input Level Multi-Function Input | 117 |
| A 3.2.3.6 | TRIGGERCOUNT, Number of Output Measurement Values | 118 |
| A 3.2.3.7 | TRIGGERSW, Software Trigger Pulse | 118 |
| A 3.2.4 | Interfaces | 119 |
| A 3.2.4.1 | BAUDRATE, RS422 | 119 |
| A 3.2.4.2 | ERROROUT1/2, Activate Switching Output | 119 |
| A 3.2.4.3 | ERRORLEVELOUT1/2, Output Level Switching Output | 119 |
| A 3.2.4.4 | ERRORLIMITCOMPARETO1/2 | 119 |
| A 3.2.4.5 | ERRORLIMITVALUES1/2 | 120 |
| A 3.2.4.6 | ERRORHYSTERESIS | 120 |
| A 3.2.4.7 | ERROROUTHOLD | 120 |
| A 3.2.5 | Handling of Setups | 121 |
| A 3.2.5.1 | IMPORT | 121 |
| A 3.2.5.2 | EXPORT | 121 |
| A 3.2.5.3 | MEASSETTINGS, Load / Save Measurement Settings | 122 |
| A 3.2.5.4 | BASICSETTINGS, Load / Save Device Settings | 123 |
| A 3.2.5.5 | SETDEFAULT, Factory Settings | 123 |
| A 3.2.6 | Analog Output | 124 |
| A 3.2.6.1 | ANALOGRANGE | 124 |
| A 3.2.6.2 | ANALOGSCALEMODE, Scaling the Analog Output | 124 |
| A 3.2.6.3 | ANALOGSCALERANGE, Scaling Limits with Two-Point Scaling | 124 |
| A 3.2.6.4 | ANALOGSCALESOURCE | 124 |
| A 3.2.7 | Key Function | 125 |
| A 3.2.7.1 | KEYLOCK, Set Key lock | 125 |

| | | |
|------------|---|-----|
| A 3.2.8 | Measurement..... | 125 |
| A 3.2.8.1 | TARGETMODE, Measurement Task | 125 |
| A 3.2.8.2 | MEASPEAK, Choice of the Peak in the Video Signal..... | 125 |
| A 3.2.8.3 | MEASRATE, Measuring Rate..... | 125 |
| A 3.2.8.4 | SHUTTER, Exposure Time | 126 |
| A 3.2.8.5 | SHUTTERMODE | 126 |
| A 3.2.8.6 | EXPOSUREMODE | 126 |
| A 3.2.8.7 | LASERPOW, Laser Power..... | 126 |
| A 3.2.8.8 | ROI, Video Signal, Masking the Evaluation Range | 126 |
| A 3.2.8.9 | COMP, Averaged Measurements..... | 127 |
| A 3.2.8.10 | List of Possible Signals for Mastering..... | 127 |
| A 3.2.8.11 | MASTER | 128 |
| A 3.2.8.12 | MASTERSIGNAL..... | 128 |
| A 3.2.8.13 | MASTERSOURCE..... | 128 |
| A 3.2.9 | Data Output..... | 129 |
| A 3.2.9.1 | OUTPUT, Selection of Measurement Value Output..... | 129 |
| A 3.2.9.2 | OUTREDUCEDEVICE, Output Reduction of Measurement Value Output..... | 129 |
| A 3.2.9.3 | OUTREDUCECOUNT, Data Output Rate..... | 129 |
| A 3.2.9.4 | OUTHOLD, Error Processing..... | 129 |
| A 3.2.9.5 | GETOUTINFO_RS422, Query Selected Data..... | 130 |
| A 3.2.9.6 | List of Possible RS422 Signals | 130 |
| A 3.2.9.7 | OUT_RS422 | 130 |
| A 3.3 | Example Command Sequence During Selection of Measurement Value..... | 131 |
| A 3.4 | Error Messages..... | 131 |
| A 4 | Control Menu | 133 |
| A 4.1 | Tab Home..... | 133 |
| A 4.2 | Tab Settings | 134 |
| A 4.2.1 | Inputs..... | 134 |
| A 4.2.2 | Data Recording..... | 135 |
| A 4.2.3 | Signal Processing..... | 137 |
| A 4.2.4 | Outputs | 138 |
| A 4.2.5 | System Settings..... | 140 |

1. Safety

The handling of the sensor assumes knowledge of the operating instructions.

1.1 Symbols Used

The following symbols are used in this operating instructions:



Indicates a hazardous situation which, if not avoided, may result in minor or moderate injury.



Indicates a situation that may result in property damage if not avoided.



Indicates a user action.



Indicates a tip for users.

Measure

Indicates hardware or a software button/menu.

1.2 Warnings

Avoid unnecessary laser radiation to be exposed to the human body.

 Switch off the sensor for cleaning and maintenance.

 Switch off the sensor for system maintenance and repair if the sensor is integrated into a system.

Caution - use of controls or adjustments or performance of procedures other than those specified may cause harm.



Connect the power supply and the display-/output device in accordance with the safety regulations for electrical equipment.

- > Risk of injury
- > Damage to or destruction of the sensor

NOTICE

Avoid shocks and impacts to the sensor.
> Damage to or destruction of the sensor

Mount the sensor only to the existing holes on a flat surface. Clamps of any kind are not permitted
> Damage to or destruction of the sensor

NOTICE

The power supply may not exceed the specified limits.

- > Damage to or destruction of the sensor

Protect the sensor cable against damage. Attach the cable load-free, hold the cable after appr. 25 cm and hold the pigtail on the connector e.g. zip tie.

- > Destruction of the sensor
- > Failure of the measuring device

Avoid continuous exposure to fluids on the sensor.

- > Damage to or destruction of the sensor

Avoid exposure to aggressive materials (washing agent, penetrating liquids or similar) on the sensor.

- > Damage to or destruction of the sensor

1.3 Notes on Product Marking

1.3.1 CE Marking

The following apply to the optoNCDT 1900:

- EU directive 2014/30/EU
- EU directive 2011/65/EU

Products which carry the CE mark satisfy the requirements of the EU directives cited and the relevant applicable harmonized European standards (EN). The measuring system is designed for use in industrial environments. The EU Declaration of Conformity is available to the responsible authorities according to EU Directive, article 10.

1.3.2 UKCA Marking

The following applies to the product:

- SI 2016 No. 1091 (“EMC“)
- SI 2012 No. 3032 (“RoHS“)

Products which carry the UKCA marking satisfy the requirements of the directives cited and the relevant applicable harmonized standards. The product is designed for use in industrial and laboratory environments. The UKCA Declaration of Conformity and the technical documentation are available to the responsible authorities according to the UKCA Directives.

1.3.3 NRTL TÜV SÜD mark

The product has been tested by TÜV SÜD America for relevant safety aspects; the production facilities are regularly inspected.

Products that bear the NRTL TÜV SÜD mark fulfill the requirements of the following cited guidelines and the respectively applicable standards:

- UL 61010-1:2012/R:2023-06
- CSA C22.2 No. 61010-1:2012/U3:2023-06
- CSA E60825-1:2015

The product is designed for use in industrial and laboratory applications. The certification applies to sensors with laser class 2. The corresponding TÜV certificate can be downloaded from the Micro-Epsilon website or requested directly from Micro-Epsilon.

1.4 Intended Use

- The optoNCDT 1900 system is designed for use in industrial and laboratory applications.
- It is used
 - for measuring displacement, distance, position and thickness
 - for in-process quality control and dimensional testing
- The system must only be operated within the limits specified in the technical data, see [Chap. 3.3](#).
- The sensor must be used in such a way that no persons are endangered or machines and other material goods are damaged in the event of malfunction or total failure of the sensor.
- Take additional precautions for safety and damage prevention in case of safety-related applications.

1.5 Proper Environment

- Protection class: IP67 (applies only when the sensor cable is plugged in)

Lenses are excluded from protection class. Contamination of the lenses leads to impairment or failure of the function.

- Pollution degree: 2
- Temperature range
 - Operation: 0 °C ... 50 °C (+32 ... +104 °F)
 - Storage: -20 °C ... 70 °C (-4 ... +158 °F)
- Area of application: Indoor and outdoor use
- Humidity: 5 ... 95 % (non-condensing)
- Installation altitude: max. 2000 m above sea level
- Ambient pressure: Atmospheric pressure

i The protection class is limited to water, no penetrating liquids or similar!

2. Laser Safety

2.1 General

The optoNCDT 1900 sensors operate with a semiconductor laser with a wavelength of 658 nm (visible/red) or 670 nm (visible/red).

i If the warning labels are covered over when the unit is installed, the user must ensure that supplementary labels are applied.

Operation of the laser is indicated visually by the LED on the sensor, see [Chap. 5.3](#).

The housing of the optical sensors may only be opened by the manufacturer, see [Chap. 11](#).

For repair and service purposes, the sensors must always be sent to the manufacturer.

Please observe national regulations, e. g., Laser Notice No. 50 for the USA.

2.2 Laser Class 2

The sensors fall within laser class 2. The laser is operated on a pulsed mode, the maximum optical power is ≤ 1 mW. The pulse frequency depends on the adjusted measuring rate (0.25 ... 10 kHz). The pulse duration of the peaks is regulated depending on the measuring rate and reflectivity of the target and can be 4 up to 3995 μ s.



Laser radiation. Irritation or injury of the eyes possible. Close your eyes or immediately turn away if the laser beam hits the eye.

i Observe the national laser protection regulations.

Although the laser output is low, directly looking into the laser beam must be avoided. Close your eyes or immediately turn away if the laser beam hits the eye. Lasers of Class 2 are not subject to notification and a laser protection officer is not required. The following warning labels (English / German) are attached to the sensor.



Fig. 1 Laser warning sign on the sensor



Fig. 2 Laser labels on the sensor cable, IL1900

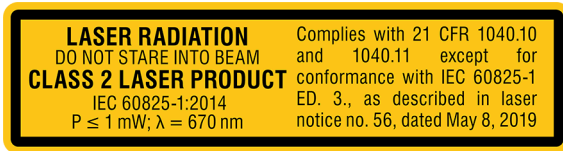

Fig. 3 Laser label on the sensor, IL1910

During operation of the sensor, the pertinent regulations according to IEC 60825-1 on „Safety of laser products“ must be fully observed at all times. The sensor complies with all applicable laws for the manufacturer of laser devices.

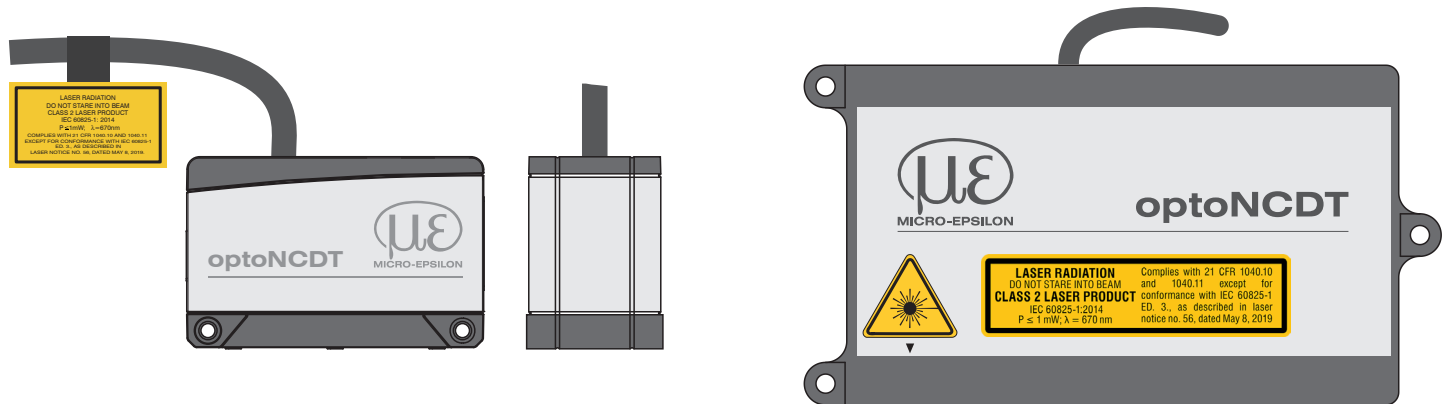

Fig. 4 True reproduction of the sensors with its actual location of the warning labels, class 2

2.3 Laser Class 3R

The sensors fall within laser class 3R. The laser is operated on a pulsed mode, the maximum optical power is ≤ 5 mW. The pulse frequency depends on the adjusted measuring rate (0.25 ... 10 kHz). The pulse duration of the peaks is regulated depending on the measuring rate and reflectivity of the target and can be 4 up to 3995 μ s.



Laser radiation. Irritation or injury of the eyes possible. Use suitable protective equipment and close your eyes or immediately turn away if the laser beam hits the eye.

i Observe the national laser protection regulations.

When operating the sensors, the relevant regulations according to IEC 60825, Part 1 of 05/2014 and the applicable accident prevention regulations must be followed.

Accordingly, the following applies:

- The accessible laser radiation is harmful to the eyes.
- Looking directly into the laser beam is harmful to the eyes with laser class 3R devices. Reflections of shiny or mirroring surfaces are also harmful to the eyes.

Class 3R laser sensors require a laser protection officer.

Mark the laser area recognizable and everlasting. During operation the laser area has to be restricted and marked.

The following warning labels are attached to the sensor cable:



Fig. 5 Laser labels on the sensor cable, ILD1900

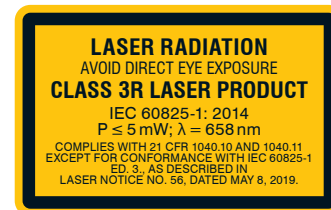

Fig. 6 Laser label on the sensor, ILD1910

In addition, the following information label must be attached to the laser output on the sensor housing:



Fig. 7 Laser warning sign on the sensor, ILD1900



Fig. 8 Laser warning sign on the sensor, ILD1910

During operation of the sensor, the pertinent regulations according to IEC 60825-1 on „Safety of laser products“ must be fully observed at all times. The sensor complies with all applicable laws for the manufacturer of laser devices.

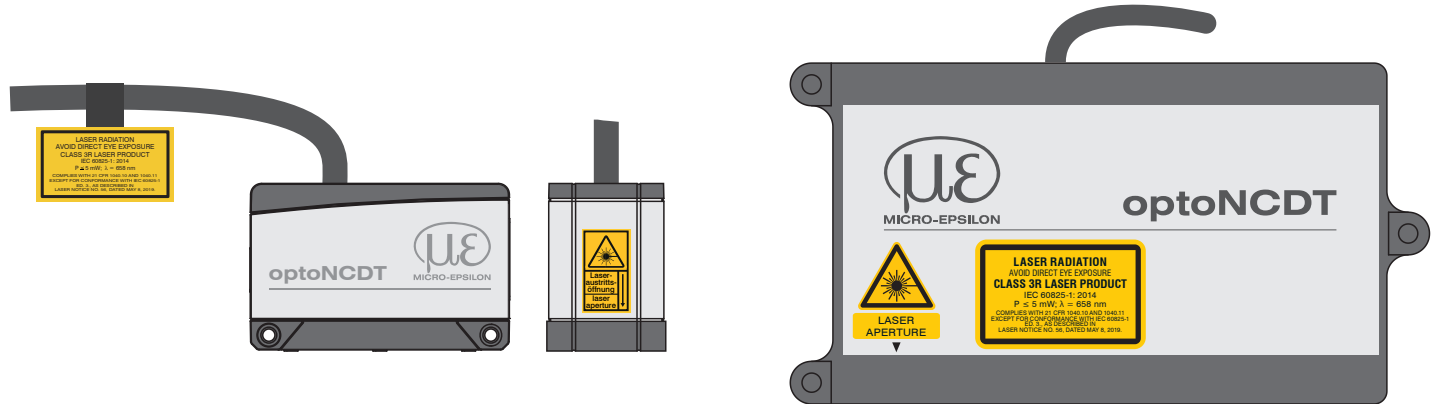

Fig. 9 True reproduction of the sensor with its actual location of the warning labels, class 3R

3. Functional Principle, Technical Data

3.1 Short Description

The optoNCDT 1900 uses the principle of optical triangulation, that is, a visible, modulated point of light is projected onto the target surface.

The diffuse part of the reflection of this point of light is displayed depending on distance on a position-resolving element (CMOS) by an receiver optic which is arranged to the optical axis of the laser beam in a defined angle.

A signal processor in the sensor calculates the distance of the point of light on the measuring object to the sensor by means of the output signal of the CMOS elements. The distance value is linearized and output by means of the analog or RS422 interface.

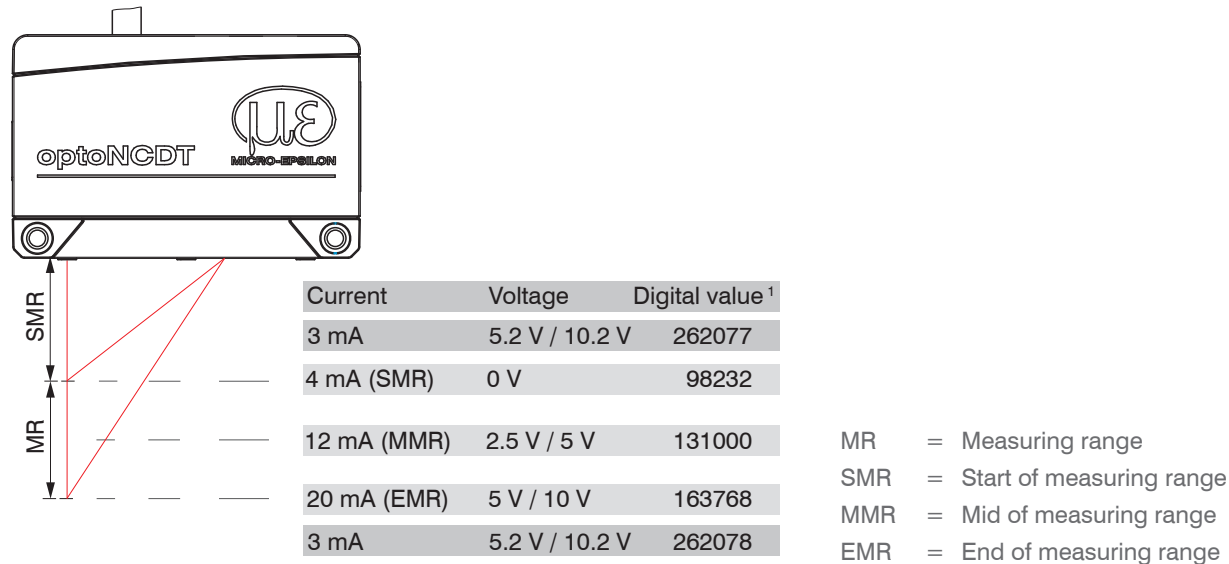

Fig. 10 Definition of terms

1) For distance values without zero setting resp. mastering only.

3.2 Advanced Surface Compensation

The optoNCDT 1900 is equipped with an intelligent surface control feature. New algorithms generate stable measurement results even on demanding surfaces where changing reflections occur. Furthermore, these new algorithms compensate for ambient light up to 50,000 lux. Therefore, this is the sensor with the highest resistance to ambient light in its class which can even be used in strongly illuminated environments.

3.3 Technical Data ILD1900-xx

| Model | ILD1900- | 2 | 6 | 10 | 25 | 50 | 100 | 200 | 500 |
|---|----------------------|---|-----------------------------------|-----------------------------------|-----------------------------------|-----------------------------------|-------------------------------------|-----------------|-----------------|
| Measuring range | mm | 2 | 6 | 10 | 25 | 50 | 100 | 200 | 500 |
| Start of measuring range | mm | 15 | 17 | 20 | 25 | 40 | 50 | 60 | 100 |
| Midrange | mm | 16 | 20 | 25 | 37.5 | 65 | 100 | 160 | 350 |
| End of measuring range | mm | 17 | 23 | 30 | 50 | 90 | 150 | 260 | 600 |
| Measuring rate ¹ | | Continuously adjustable between 0.25 ... 10 kHz adjustable in 7 steps: 10 kHz / 8 kHz / 4 kHz / 2 kHz / 1.0 kHz / 500 Hz / 250 Hz | | | | | | | |
| Linearity ² | μm | $\leq \pm 1$ | $\leq \pm 1.8$ | $\leq \pm 2$ | $\leq \pm 5$ | $\leq \pm 10$ | $\leq \pm 30$ | $\leq \pm 100$ | $\leq \pm 400$ |
| | % FSO | $\leq \pm 0.05$ | $\leq \pm 0.03$ | $\leq \pm 0.02 \%$ | | | $\leq \pm 0.03$ | $\leq \pm 0.05$ | $\leq \pm 0.08$ |
| Repeatability ³ | μm | < 0.1 | ≤ 0.25 | < 0.4 | < 0.8 | < 1.6 | < 4 | < 8 | $< 20 \dots 40$ |
| Temperature stability ⁴ | % FSO/K | ± 0.005 | | | | | | | |
| Spot diameter ($\pm 10 \%$) ⁵ | SMR in μm | 60 x 75 | 85 x 105 | 115 x 150 | 200 x 265 | 220 x 300 | 310 x 460 | 950 x 1200 | 950 x 1200 |
| | MMR in μm | 55 x 65 | 57 x 60 | 60 x 65 | 70 x 75 | 95 x 110 | 140 x 170 | | |
| | EMR in μm | 65 x 75 | 105 x 120 | 120 x 140 | 220 x 260 | 260 x 300 | 380 x 410 | - | - |
| | smallest diameter | 55 x 65 μm at 16 mm | 57 x 60 μm at 20 mm | 60 x 65 μm at 25 mm | 65 x 70 μm at 35 mm | 85 x 90 μm at 55 mm | 120 x 125 μm at 75 mm | | |
| Light source | | Semiconductor laser $\leq 1 \text{ mW}$, 670 nm (red) with Class 2 Semiconductor laser $\leq 5 \text{ mW}$, 658 nm (red) with Class 3R | | | | | | | |
| Laser class | | Class 2 according to IEC 60825-1: 2014 optionally Class 3R according to IEC 60825-1: 2014 | | | | | | | |
| Permissible ambient light | | 50.000 lx | | | | | 30.000 lx | 10.000 lx | |
| Supply voltage | | 11 ... 30V DC, LPS and NEC Class 2 compliant | | | | | | | |
| Power consumption | | $< 3 \text{ W}$ (24 V) | | | | | | | |
| Control inputs | | 1 x HTL/TTL Laser on/off; 1 x HTL/TTL Multifunction input Trigger in / slave in / zero setting / mastering / teach 1x RS422 synchronization input (trigger in, sync in, master/slave, master/slave alternating) | | | | | | | |

| Model | ILD1900- | 2 | 6 | 10 | 25 | 50 | 100 | 200 | 500 |
|---------------------------------|-----------|--|---|----|----|----|-----|-----|-----|
| Digital interface | | RS422 / 18 bit, PROFINET ⁶ , EtherNet/IP ⁶ | | | | | | | |
| Analog output | | 4 ... 20 mA / 0 ... 5 V / 0 ... 10 V (16 bit; freely scalable within the measuring range) | | | | | | | |
| Switching output | | 2 x switching output (error & limit value): npn, pnp, push pull | | | | | | | |
| Synchronization | | Possible for simultaneous or alternating measurements | | | | | | | |
| Connection | | Integrated cable with 3 m length, open ends, min. bending radius 30 mm fixed mounted; or 0.3 m pigtail with 17-pol. M12 connector optional extension on 3 m / 6 m / 9 m / 15 m possible | | | | | | | |
| Temperature range | Storage | -20 ... +70 °C (-4 ... +158 °F), (non-condensing) | | | | | | | |
| | Operation | 0 ... +50 °C (+32 ... +122 °F), (non-condensing) | | | | | | | |
| Shock (DIN-EN 60068-2-27) | | 15 g / 6 ms | | | | | | | |
| Vibration (DIN-EN 60068-2-6) | | 30 g / 20 ... 500 Hz | | | | | | | |
| Protection class (DIN-EN 60529) | | IP67 | | | | | | | |
| Material | | Aluminum housing | | | | | | | |
| Weight | | appr. 185 g (with pigtail), appr. 300 g (with cable) | | | | | | | |
| Control and Display Elements | | Select & function buttons: interface selection, mastering (zero), teach, presets, quality slider, frequency selection, factory settings Web interface for setup ⁷ : application-specific presets, peak selection, video signal, freely selectable averaging possibilities, data reduction, setup management 2 x color LED for power / state | | | | | | | |

FSO = Full Scale Output, SMR = Start of measuring range, MMR = Mid of measuring range, EMR = End of measuring range

The specified data apply to a white, diffuse reflecting surface (Micro-Epsilon reference ceramic for ILD sensors)

1) Factory setting: 4 kHz measuring rate, median 9; to change the factory setting requires an IF2001/USB converter, see [Chap. A 1](#)

2) Related to digital output

3) Typical value with measurements at 4 kHz and median 9

4) Related to digital output in the mid of the measuring range; the specified value is only achieved by mounting on a metallic sensor holder. Good heat dissipation from the sensor to the holder must be ensured.

5) Light spot diameter determined using a point-shaped laser with Gaussian fit (full 1/e² width); for ILD1900-2: determined with emulated 90/10 knife-edge method

6) Connection with interfaces, see [Chap. A 1](#) (optional accessories)

7) Connection to PC via IF2001/USB, see [Chap. A 1](#) (optional accessories)

3.4 Technical Data ILD1900-xxLL

| Modell | ILD1900- | 2LL | 6LL | 10LL | 25LL | 50LL |
|--|----------------------|---|------------------------------------|------------------------------------|--------------------------------------|--------------------------------------|
| Measuring range | mm | 2 | 6 | 10 | 25 | 50 |
| Start of measuring range | mm | 15 | 17 | 20 | 25 | 40 |
| Midrange | mm | 16 | 20 | 25 | 37.5 | 65 |
| End of measuring range | mm | 17 | 23 | 30 | 50 | 90 |
| Measuring rate ¹ | | Continuously adjustable between 0.25 ... 10 kHz; adjustable in 7 steps: 10 kHz / 8 kHz / 4 kHz / 2 kHz / 1.0 kHz / 500 Hz / 250 Hz | | | | |
| Linearity ² | μm | < ± 1 | < ± 1.2 | < ± 2 | < ± 5 | < ± 10 |
| | % FSO | < ± 0.05 | < ± 0.02 | < ± 0.02 | < ± 0.02 | < ± 0.02 |
| Repeatability ³ | μm | < 0.1 | < 0.25 | < 0.4 | < 0.8 | < 1.6 |
| Temperature stability ⁴ | % FSO/ K | ± 0.005 | | | | |
| Spot diameter ($\pm 10\%$) ⁵ | SMR in μm | 55 x 480 | 100 x 600 | 125 x 730 | 210 x 950 | 235 x 1280 |
| | MMR in μm | 40 x 460 | 50 x 565 | 55 x 690 | 80 x 970 | 125 x 1500 |
| | EMR in μm | 55 x 440 | 100 x 525 | 125 x 660 | 220 x 1000 | 325 x 1740 |
| | smallest diameter | 40 x 460 μm at 16 mm | 50 x 565 μm at 20 mm | 55 x 690 μm at 25 mm | 80 x 970 μm at 37.5 mm | 115 x 1450 μm at 59 mm |
| Light source | | Semiconductor laser ≤ 1 mW, 670 nm (red) with Class 2 Semiconductor laser ≤ 5 mW, 658 nm (red) with Class 3R | | | | |
| Laser class | | Class 2 according to IEC 60825-1: 2014 optional Class 3R DIN EN 60825-1: 2015-07 | | | | |
| Permissible ambient light | | 50.000 lx | | | | |
| Supply voltage | | 11 ... 30 VDC, LPS and NEC Class 2 compliant | | | | |
| Power consumption | | < 3 W (24 V) | | | | |
| Control inputs | | 1 x HTL/TTL Laser on/off; 1 x HTL/TTL Multifunction input Trigger in / slave in / zero setting / mastering / teach 1x RS422 synchronization input (trigger in, sync in, master/slave, master/slave alternating) | | | | |
| Digital interface | | RS422 / 18 bit, PROFINET ⁶ EtherNet/IP ⁶ | | | | |

| Modell | ILD1900- | 2LL | 6LL | 10LL | 25LL | 50LL |
|---------------------------------|-----------|--|-----|------|------|------|
| Analog output | | 4 ... 20 mA / 0 ... 5 V / 0 ... 10 V (16 bit; freely scalable within the measuring range) | | | | |
| Switching output | | 2 x switching output (error & limit value): npn, pnp, push pull | | | | |
| Synchronization | | Possible for simultaneous or alternating measurements | | | | |
| Connection | | Integrated cable with 3 m length, open ends, min. bending radius 30 mm fixed mounted; or 0.3 m pigtail with 17-pol. M12 connector optional extension on 3 m / 6 m / 9 m / 15 m possible | | | | |
| Temperature range | Storage | -20 ... +70 °C (-4 ... +158 °F), (non-condensing) | | | | |
| | Operation | 0 ... +50 °C (+32 ... +122 °F), (non-condensing) | | | | |
| Shock (DIN-EN 60068-2-27) | | 15 g / 6 ms in 3 axes | | | | |
| Vibration (DIN-EN 60068-2-6) | | 30 g / 20 ... 500 Hz | | | | |
| Protection class (DIN-EN 60529) | | IP67 | | | | |
| Material | | Aluminum housing | | | | |
| Weight | | appr. 185 g (with pigtail), appr. 300 g (with cable) | | | | |
| Control and display elements | | Select & function buttons: interface selection, mastering (zero), teach, presets, quality slider, frequency selection, factory settings Web interface for setup ⁷ : application-specific presets, peak selection, video signal, freely selectable averaging possibilities, data reduction, setup management 2 x color LED for power / state | | | | |

FSO = Full Scale Output, SMR = Start of measuring range, MMR = Mid of measuring range, EMR = End of measuring range

The specified data apply to a white, diffuse reflecting surface (Micro-Epsilon reference ceramic for ILD sensors)

1) Factory setting: 4 kHz measuring rate, Median 9; to change the factory setting requires an IF2001/USB converter, see [Chap. A 1](#)

2) Related to digital output

3) Typical value with measurements at 4 kHz and median 9

4) Related to digital output in the mid of the measuring range; the specified value is only achieved by mounting on a metallic sensor holder. Good heat dissipation from the sensor to the holder must be ensured.

5) Light spot diameter with line-shaped laser determined based on the emulated 90/10 knife-edge method

6) Connection with interfaces, see [Chap. A 1](#) (optional accessories)

7) Connection to PC via IF2001/USB, see [Chap. A 1](#) (optional accessories)

3.5 Technical Data ILD1910

| Model | ILD1910-500 | ILD1910-750 |
|--|---|----------------|
| Measuring range | 500 mm | 750 mm |
| Start of measuring range | 200 mm | 200 mm |
| Mid of measuring range | 450 mm | 575 mm |
| End of measuring range | 700 mm | 950 mm |
| Measuring rate ¹ | continuously adjustable between 0.25 ... 9.5 kHz or 7 adjustable stages: 9.5 kHz / 8 kHz / 4 kHz / 2 kHz / 1.0 kHz / 500 Hz / 250 Hz | |
| Linearity ² | < ±0.07 % FSO | ±0.08 % FSO |
| | ±350 μm | ±600 μm |
| Repeatability ³ | 20 μm | 30 μm |
| Light spot diameter ⁴ | 800 x 800 μm | 1100 x 1100 μm |
| Light source | Semiconductor laser ≤ 1 mW, 670 nm (red) with laser class 2 | |
| Laser class | Class 2 in accordance with IEC 60825-1: 2014 (Class 3 available on request) | |
| Permissible ambient light ⁵ | 10,000 lx | |
| Supply voltage | 11 ... 30 VDC, LPS and NEC Class 2 compliant | |
| Power consumption | < 3 W (24 V) | |
| Signal input | 1 x HTL/TTL laser on/off; 1 x HTL/TTL multi-function input: trigger in, slave in, zero setting, mastering, teach-in; 1 x RS422 synchronization input: trigger in, sync in, master/slave, master/slave alternating | |

1 Factory setting 4 kHz, median 9, modifying the factory setting requires the IF2001/USB converter (see accessories)

2 FSO = Full Scale Output; data related to the digital output and valid for white, diffusely reflecting surfaces (Micro-Epsilon reference ceramic for ILD sensors)

3 Typical value with measurements at 4 kHz and median 9

4 ±15 %; light spot diameter determined with point-shaped laser with Gaussian fit (full 1/e² width)

5 Illuminant: light bulb

| Model | | ILD1910-500 | ILD1910-750 |
|---|-----------|--|-------------|
| Digital interface ⁶ | | RS422 (18 bit) / EtherCAT / PROFINET / EtherNet/IP | |
| Analog output | | 4 ... 20 mA / 0 ... 5 V / 0 ... 10 V (16 bit, freely scalable within the measuring range) | |
| Switching output | | 2x switching outputs (error & limit value): npn, pnp, push pull | |
| Connection | | integrated cable 3 m, open ends, min. bending radius 30 mm (fixed installation); or integrated pigtail 0.3 m with 17-pin M12 plug; optional extension to 3 m / 6 m / 9 m / 15 m possible (suitable connection cable see Accessories) | |
| Temperature range | Storage | -20 ... +70 °C (non-condensing) | |
| | Operation | 0 ... +50 °C (non-condensing) | |
| Shock (DIN EN 60068-2-27) | | 15 g / 6 ms in 3 axes | |
| Vibration (DIN EN 60068-2-6) | | 2 g / 20 ... 500 Hz | |
| Protection class (DIN EN 60529) | | IP65 | |
| Material | | Aluminum housing | |
| Weight | | approx. 600 g (incl. pigtail) | |
| Control and indicator elements ⁷ | | Select & function keys: interface selections, mastering (zero), teach, presets, quality slider, frequency selection, factory settings; web interface for setup: application-specific presets, peak selection, video signal, freely selectable averaging possibilities, data reduction, setup management; 2 x color LEDs for power / status | |

⁶ For EtherCAT, PROFINET and EtherNet/IP, connection via interface module is required (see accessories)

⁷ Access to web interface requires connection to PC via IF2001/USB (see accessories)

4. Delivery

4.1 Unpacking, Included in Delivery

- 1 Sensor ILD1900/1910
- 1 Assembly instruction
- 1 Calibration protocol
- Accessories (2 pieces screw M3 x 40 and 2 pieces centering elements)

- ➡ Carefully remove the components of the measuring system from the packaging and ensure that the goods are forwarded in such a way that no damage can occur.
- ➡ Check the delivery for completeness and shipping damage immediately after unpacking.
- ➡ If there is damage or parts are missing, immediately contact the manufacturer or supplier.

Optional accessories are available in the appendix, see [Chap. A 1](#).

4.2 Storage

Storage temperature: -20 ... +70 °C (-4 ... +158 °F)

Humidity: 5 ... 95 % (non-condensing)

5. Installation

5.1 Instructions for Installation

5.1.1 Reflection Factor of the Target Surface

In principle the sensor evaluates the diffuse part of the reflected laser light.

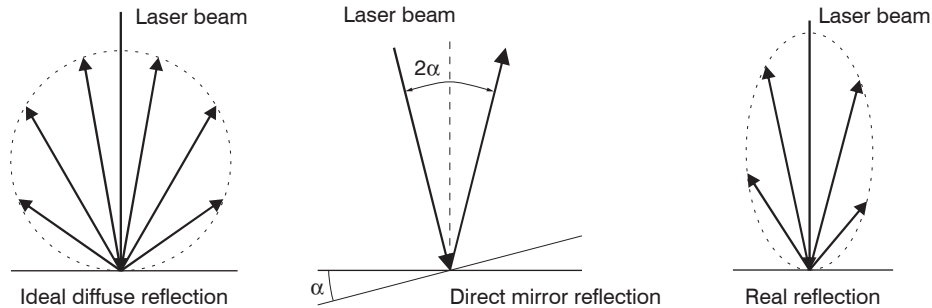

Fig. 11 Reflection factor of the target surface

A statement concerning a minimum reflectance is difficult to make because even a small diffuse fraction can be evaluated from highly reflecting surfaces. This is done by determining the intensity of the diffuse reflection from the CMOS signal in real time and subsequent compensation, see [Chap. 3.2](#). Dark or shiny objects being measured, e.g. black rubber, may require longer exposure times. The maximum exposure time is dependent on the measuring rate and can only be increased by reducing the sensor's measuring rate.

5.1.2 Error Influences

5.1.2.1 Light from Other Sources

Thanks to their integrated optical interference filters the optoNCDT 1900 sensors offer outstanding performance in suppressing light from other sources. However, this does not preclude the possibility of interference from other light sources if the objects being measured are shiny and if lower measuring rates are selected. Should this be the case it is recommended to use suitable shields to screen the other light sources or switch on the background suppression function. This applies in particular to measurement work performed in close proximity to welding equipment.

5.1.2.2 Color Differences

Because of intensity compensation, color difference of targets affect the measuring result only slightly. However, such color differences are often combined with different penetration depths of the laser light into the material. Different penetration depths then result in apparent changes of the measuring spot size. Therefore color differences in combination with changes of penetration depth may lead to measuring errors.

5.1.2.3 Temperature Influences

When the sensor is commissioned a warm-up time of at least 20 minutes is required to achieve uniform heat distribution in the sensor. If measurement is performed in the micron accuracy range, the effect of temperature fluctuations on the sensor holder must be considered. Due to the damping effect of the heat capacity of the sensor, sudden temperature changes are only measured with delay.

5.1.2.4 Mechanical Vibration

If the sensor is to be used for resolutions in the μm to sub- μm range, special care must be taken to ensure stable and vibration-free mounting of sensor and target.

5.1.2.5 Movement Blurs

If the objects being measured are fast moving and the measuring rate is low, it is possible that movement blurs may result. Always select a high measuring rate for high-speed operations, therefore, in order to prevent errors.

5.1.2.6 Surface Roughness

Laser-optical sensors detect the surface using an extremely small laser spot. They also track slight surface unevenness. In contrast, a tactile, mechanical measurement, e.g. using a caliper, detects a much larger area of the measurement object. In case of traversing measurements, surface roughnesses of $5\ \mu\text{m}$ and more lead to an apparent distance change.

Suitable parameters for the averaging number may improve the comparability of optical and mechanical measurements.

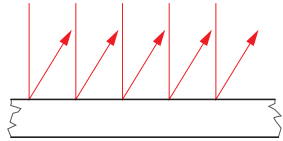

Ceramic reference surface

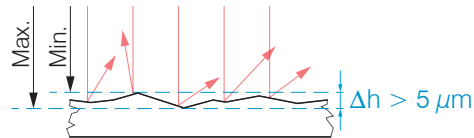

Structured surface

Recommendation for parameter choice:

The averaging number should be selected in such a way that a surface area the size of which is comparable to those with mechanical measurements is averaged.

5.1.2.7 Angle Influences

Tilt angles of the target in diffuse reflection both around the X and the Y axis of less than 5° only have a disturbing effect with surfaces which are highly reflecting.

These influences have to be explicitly considered when scanning profiled surfaces. Basically the angle behavior of triangulation is liable to the reflectivity of the measuring object surface.

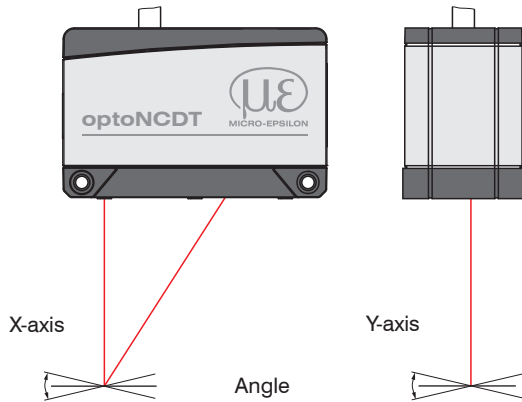
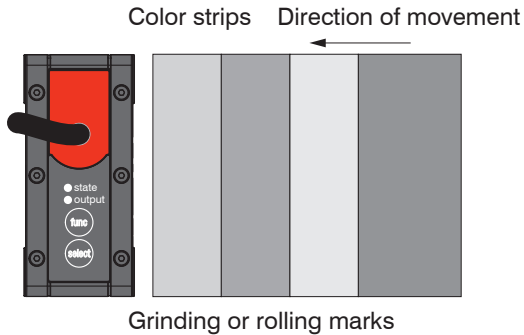

Fig. 12 Measurement errors through tilting with diffuse reflection

5.1.3 Optimizing the Measuring Accuracy



In case of rolled or polished metals that are moved past the sensor the sensor plane must be arranged in the direction of the rolling or grinding marks. The same arrangement must be used for color strips.

Fig. 13 Sensor arrangement in case of ground or striped surfaces

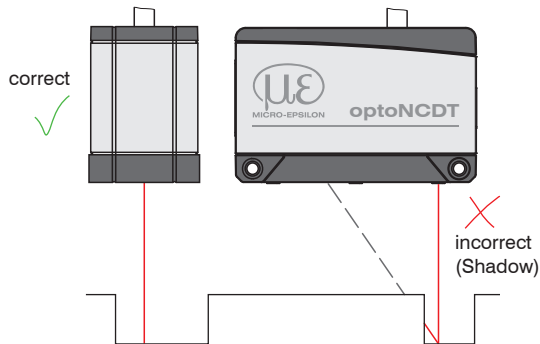

In case of bore holes, blind holes and edges in the surface of moving targets the sensor must be arranged in such a way that the edges do not obscure the laser spot.

Fig. 14 Sensor arrangement for holes and ridges

5.2 Mounting

5.2.1 General

The optoNCDT 1900 sensor is an optical system for measurements with micrometer accuracy. The laser beam must be directed perpendicularly onto the surface of the target.

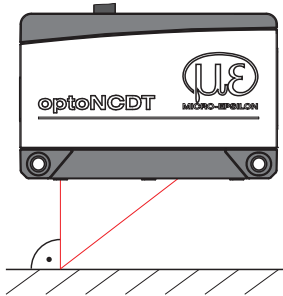

i Make sure it is handled carefully when installing and operating. Mount the sensor only to the existing holes on a flat surface. Clamps of any kind are not permitted. Do not exceed torques.

The bearing surfaces surrounding the through holes (mounting holes) are slightly raised.

Fig. 15 Sensor mounting with diffuse reflection

5.2.2 Attachment, Dimensions ILD1900

Depending on the installation position, it is recommended to define the sensor position using centering elements and fitting bores. The cylindrical counterbore $\varnothing 6H7$ is intended for the position-defining centering elements. This allows for the sensor to be mounted in a reproducible and exchangeable way.

Bolt connection

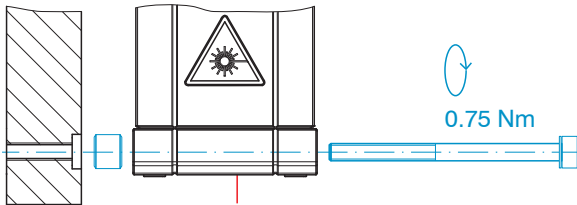

M3 x 40; ISO 4762, A2-70

Direct fastening

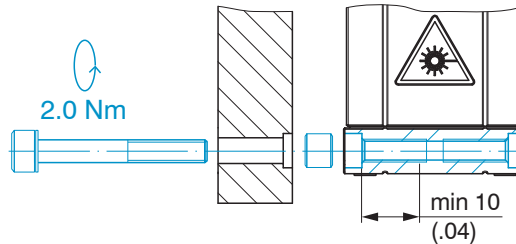

M4; ISO 4762, A2-70
Screw depth min 10 mm

5.2.3 Attachment, Dimensions ILD1910

Bolt connection

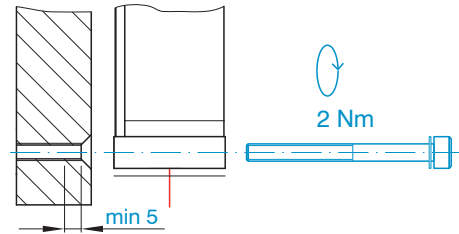

- Through length 35 mm
- Screw depth min 5 mm
- Screw M4 (ISO 4762-A2)
- Washer A4.3 (ISO 7089-A2)
- Torque 2 Nm ($\mu = 0.12$)

i Mount the sensor only to the existing holes on a flat surface. Clamps of any kind are not permitted. Do not exceed torques.

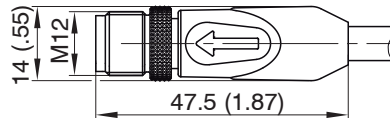

Fig. 18 Dimensional drawing male connector sensor cable

MR = Measuring range

SMR = Start of measuring range

optoNCDT 1900

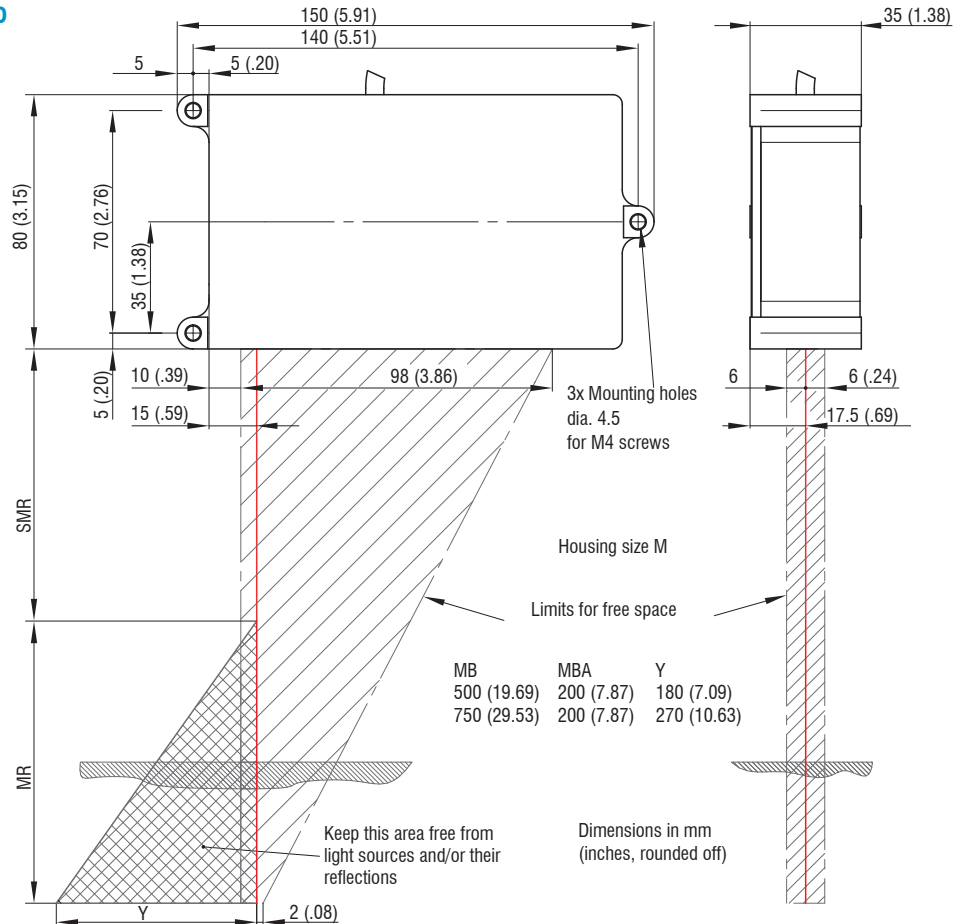
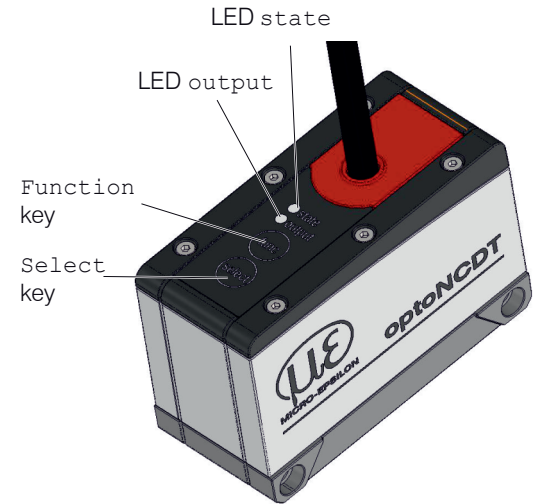

Fig. 19 Dimensional drawing and free space, ILD1910-500/750

5.3 Indicator Elements at Sensor

| LED State | Meaning |
|------------|---|
| Green | Measuring object within sensor range |
| Yellow | Mid range |
| Red | no displacement value available - e.g. Poor target or out of range |
| off | Laser off |
| LED Output | Meaning |
| Green | RS422 measurement value output on, analog output off |
| Yellow | The switching outputs are active. The RS422 or the analog output can be switched on. The web interface can also be switched on. |
| Red | Measurement value output: current with 4 ... 20 mA or voltage with 0 ... 5 V resp. 0 ... 10 V is active |
| Off | Sensor off, no supply |

| Key Function | Meaning |
|--------------|--|
| | Sensor parameterization <ul style="list-style-type: none"> - during initialization of sensor: selection of interface and key function (mastering or teaching) - in measurement mode: selection of the functions Presets, Averaging and Measurement frequency, see Chap. 6.8. |
| Key Select | Meaning |
| | <ul style="list-style-type: none"> - Sensor parameterization - Teaching or mastering |



The web interface or the ASCII commands enable programming of the Select key and setting of the key lock.

The keys have a key lock function. By default, the two keys are active for five minutes after having switched on the power supply. Afterwards, they are automatically locked in order to avoid misuse.

5.4 Electrical Connections

5.4.1 Connection Possibilities

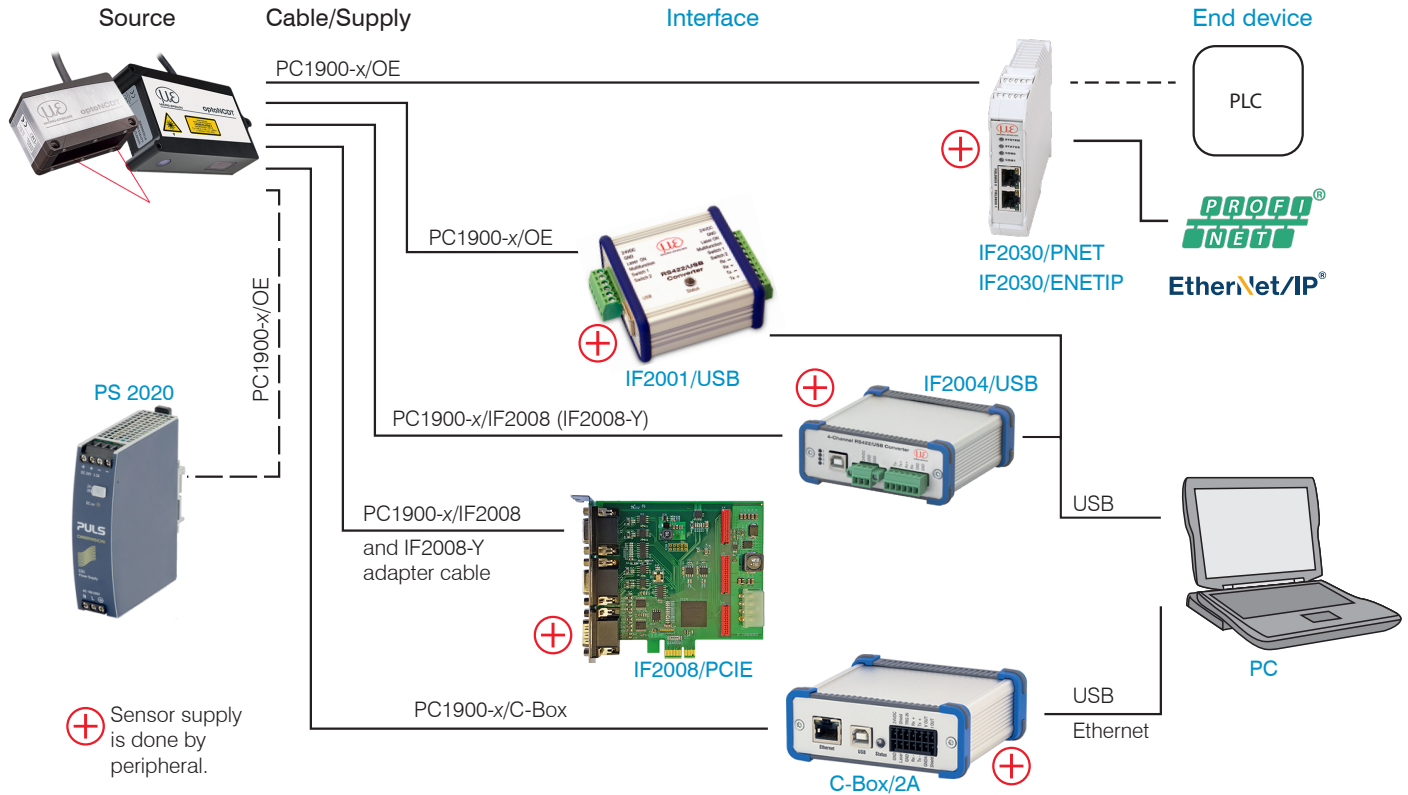
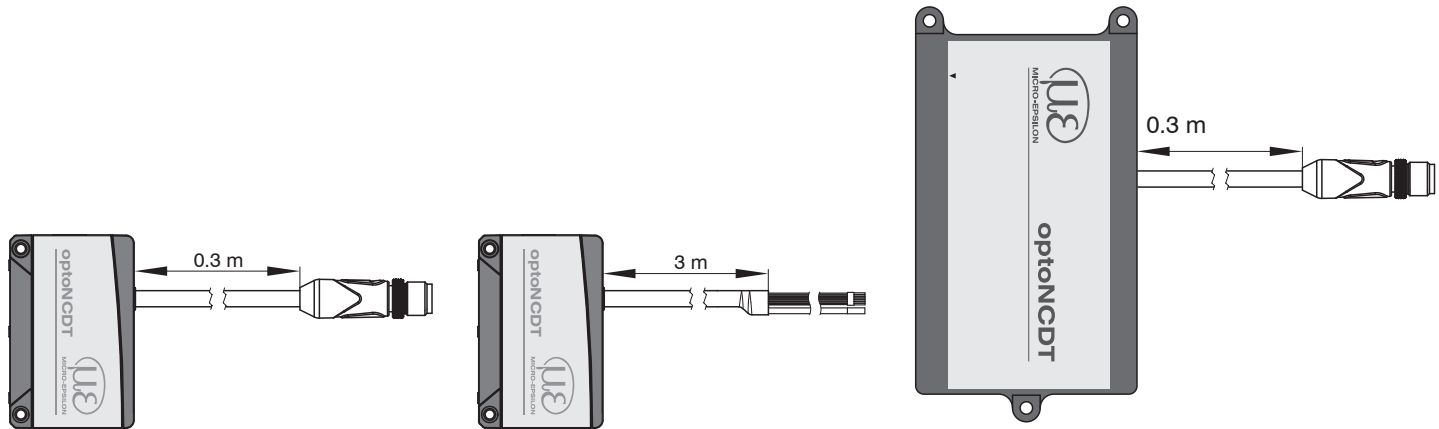

Fig. 20 Connection examples on ILD1900



ILD1900 with pigtail

ILD1900 with open ends

ILD1910 with pigtail

The different periphery devices, see Fig. 20, can be connected by the illustrated connection cables to the 17-pin sensor male plug resp. to the open ends.

| Peripheral | Sensor channels | Power supply for the sensor is provided | Power supply converter/modules | Interface |
|---------------------------------|-----------------|---|--|------------------------------|
| IF2001/USB, RS422-USB converter | one | yes | optional available power supply PS2020 | RS422 |
| IF2030/PNET, IF2030/ENETIP | one | yes | | |
| C-Box/2A | two | yes | | |
| IF2004/USB | four | yes | | |
| IF2008/PCIE, PCI interface card | four | yes | | |
| PLC, ILD1900 or the like | --- | | | Functional input: trigger |
| Switch, key, PLC or the like | --- | | | Switching input laser On/Off |

Fig. 21 Max. sensor channels on the peripheral devices

5.4.2 Pin Assignment

| Signal | Pin | Color sensor cable PC1900-x/OE, Description | | Specification, Wiring |
|---------------------|-----|---|---|--|
| V_+ | 5 | Red | Supply voltage (11 ... 30 VDC) | |
| GND | 14 | Blue | System ground for power supply, switch signals (Laser on/off, Zero, Limits) | |
| Analog output | 1 | Coaxial inner conductor, white | Current 4 ... 20 mA | $R_B < (V_+ - 6 \text{ V}) / 20 \text{ mA}$, see Chap. 5.4.5 $R_i = 50 \text{ Ohm}$, $I_{max} = 5 \text{ mA}$ |
| | | | Voltage 0 ... 5 VDC Voltage 0 ... 10 VDC | |
| AGND | 2 | Coaxial screening, black | Reference potential for analog output | |
| Laser on/off | 3 | Black | Switching input | Laser is active, if Pin 3 is connected with GND, see Chap. 5.4.4 |
| Multifunction input | 13 | Violet | Switching input | TrigIn, Zero/Master, TeachIn, SlaveIn, see Chap. 5.4.6 |
| Error/Limit 1 | 10 | Brown | Switching output 1 | Programmable switching characteristic: (NPN, PNP, Push-Pull), see Chap. 5.4.8 . |
| Limit 2 | 11 | White | Switching output 2 | |
| Sync + | 17 | Grey-pink | Symmetrical synchron output (Master) or input (Slave) ¹⁾ | RS422 level, terminating resistor 120 Ohm switchable, input or output selected depending on the synchronization mode |
| Sync - | 12 | Red-blue | | |
| Tx + | 8 | Grey | RS422 - Output (symmetric) | Terminate receiver with 120 Ohm |
| Tx - | 15 | Pink | | |
| Rx + | 9 | Green | RS422 - Input (symmetric) | Internally terminated with 120 Ohm |
| Rx - | 16 | Yellow | | |

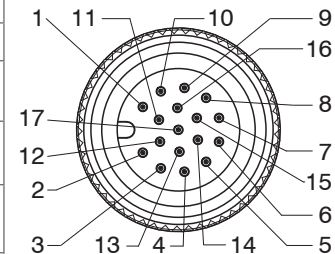

17-pin connector, M12, pin side male cable connector pigtail

The sensor cable PC1900 is cable carriers suitable.

One end has a molded female cable connector, the other end has free leads with ferrules.

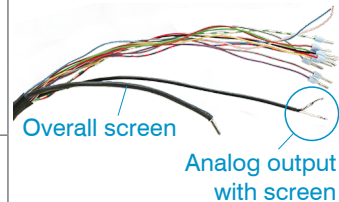

PC1900-x with open ends

1) Used as trigger inputs in mode „Triggering“.

5.4.3 Supply Voltage

Nominal value: 24 V DC (11 ... 30 V, $P < 3$ W).

- ▶ Switch on the power supply unit once wiring is completed.
- ▶ Connect the inputs „5“ and „14“ at the sensor with a 24 V voltage supply.

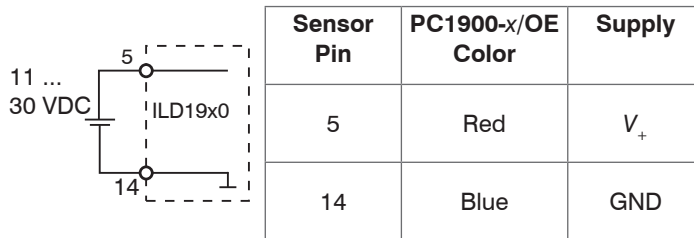

Use the supply voltage for measurement instruments only and not for drive units or similar sources of pulse interference at the same time. Micro-Epsilon recommends using an optional available power supply unit PS2020 for the sensor. Use a power supply that conforms to LPS or NEC Class 2.

Fig. 22 Connection of supply voltage

5.4.4 Laser On

The measuring laser on the sensor is activated via a switch input (HTL or TTL level). This is advantageous if the sensor has to be switched off for maintenance or similar. Switching can be done with a transistor (for example open collector in an optocoupler), a relay contact or a digital TTL/HTL signal.

i If pin 3 is not connected electrically with Pin 14, the laser is off.

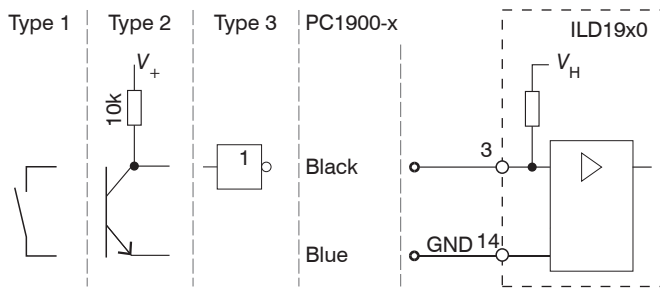

Inputs are not galvanically isolated.

24V level (HTL): Low ≤ 3 V; High ≥ 8 V (max 30 V),

5V level (TTL): Low ≤ 0.8 V; High ≥ 2 V

Internal pull-up resistor, an open input is identified as High.

Max. switching frequency 10 Hz

Fig. 23 Electrical wiring for laser on/off

There is no external resistor for current limiting required. Connect Pin 3 with Pin 14 for permanent „Laser on“.

Reaction Time for Laser-On: After the laser was switched on, correct measuring data are sent by the sensor approximately 10 ms later.

5.4.5 Analog Output

The sensor alternatively provides a

- current output with 4 ... 20 mA or a
- voltage output with 0 ... 5 V resp. 0 ... 10 V.

I The output may not be continuously operated in short circuit operation without load resistor. The short circuit operation leads to durable thermal overload and thus for automatic overload shutdown of the output.

➡ Connect the output 1 (white, coaxial inner conductor) and 2 (black, coaxial screening) on the sensor to a measuring device.

| Sensor | |
|-------------------------------|--------------|
| 17-pin female cable connector | Sensor cable |
| OUT (Pin 1) | White |
| GND (Pin 2) | Black |
| $R_i = 50 \text{ Ohm}$ | |

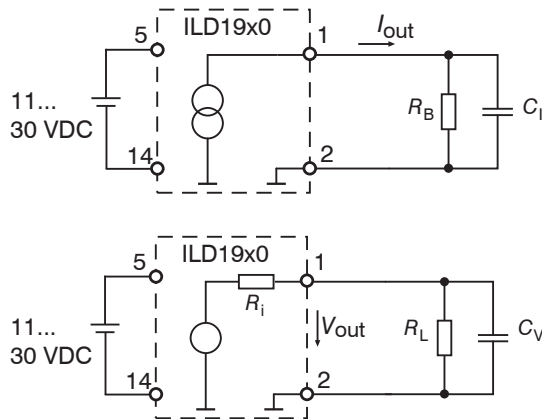

Current output

$$R_B < (V_+ - 6 \text{ V}) / 20 \text{ mA};$$

$$R_B \text{ max.} = 250 \text{ Ohm at } V_+ = 11 \text{ V}$$

$$C_I \leq 33 \text{ nF}$$

Voltage output

$$R_i = 50 \text{ Ohm}, I_{\text{max}} = 5 \text{ mA},$$

short circuit protection at 7 mA

$$R_L > 20 \text{ MOhm}$$

$$C_V \leq 100 \text{ nF}$$

Fig. 24 Wiring for analog output

5.4.6 Multifunction Input

The multifunctional input enables the functions Triggering, Zeroing/Mastering and Teaching. The function is dependent on the programming of the input and of the time behavior of the input signal. The inputs are not galvanically isolated, the maximum switching frequency is 10 kHz.

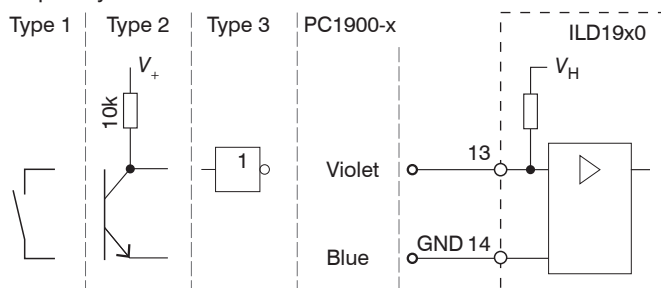

Fig. 25 Electrical wiring for multifunctional input

24V level (HTL): Low ≤ 3 V; High ≥ 8 V (max 30 V)

5V level (TTL): Low ≤ 0.8 V; High ≥ 2 V

Internal pull-up resistor, an open input is identified as high.

Connect the input with GND, to start the function.

5.4.7 RS422 Connection with USB Converter IF2001/USB

Cross the lines for connections between sensor and PC.

i Disconnect or connect the D-sub connection between RS422 and USB converter when the sensor is disconnected from power supply only.

| Sensor | | End device (converter) Type IF2001/USB from Micro-Epsilon |
|--|------------------------------------|---|
| 17-pin male cable connector; Connection sensor cable | Sensor cable PC1900-x/OE | |
| 24VDC (Pin 5) | Red | 24VDC |
| GND (Pin 14) | Blue | GND (Pin 9) |
| Laser On (Pin 3) | Black | Laser on |
| Tx - (Pin 15) | Pink | Rx - (Pin 4) |
| Tx + (Pin 8) | Grey | Rx + (Pin 3) |
| Rx - (Pin 16) | Yellow | Tx - (Pin 2) |
| Rx + (Pin 9) | Green | Tx + (Pin 1) |

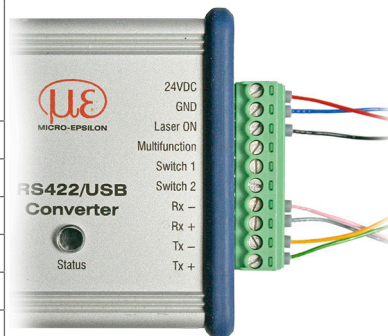

Symmetric differential signals acc. to EIA-422, not galvanically isolated from supply voltage.

Use a shielded cable with twisted cores e.g. PC1900-x/OE.

Fig. 26 Pin assignment IF2001/USB

| Terminal Converter |
|--------------------|
| 24 VDC |
| GND |
| Laser ON |
| Multifunction |
| Switch 1 |
| Switch 2 |

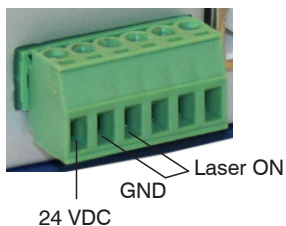

➡ Connect GND with Laser ON to permanently activate the laser light source in the sensor 1

5.4.8 Switching Output

The switching characteristic (NPN, PNP, Push-Pull, Push-Pull negated) of both switching outputs (digital outputs) depends on the programming.

The NPN output is e.g. suitable for adjustment to TTL logics with an auxiliary voltage $V_H = +5\text{ V}$. The switching outputs (digital outputs) are protected against reverse polarity, overloading ($> 100\text{ mA}$) and over temperature.

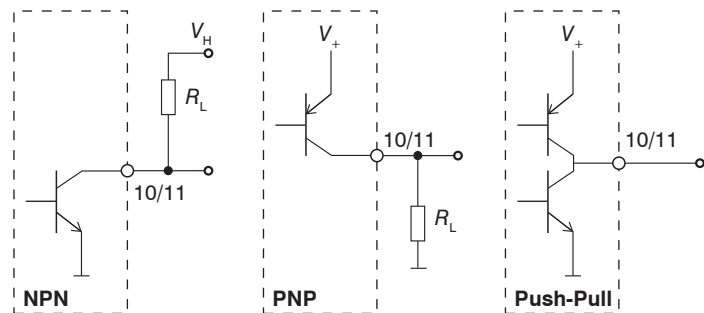

Output is not galvanically isolated.

24V level (HTL),

$I_{\max} = 100\text{ mA}$,

$V_{H, \max} = 30\text{ V}$ saturation voltage at $I_{\max} = 50\text{ mA}$:

$V_{\text{sat, low}} < 1.5\text{ V}$ (output - GND),

$V_{\text{sat, high}} < 1.5\text{ V}$ (output - V_+)

Fig. 27 Electrical wiring switching output

| Switching characteristic | | |
|--------------------------|---------------------------------------|--|
| Description | Output active (error, limit value) | Output passive (no error, no off-limit condition) |
| NPN (Low side) | GND | appr. V_H |
| PNP (High side) | V_+ | appr. GND |
| Push-Pull | V_+ | GND |
| Push-Pull, negated | GND | V_+ |

Fig. 28 Switching characteristic switching output

The switching outputs are activated when measuring object is missing, measuring object too close/too far, no valid measurement value or with an off-limit condition.

5.4.9 Connector and Sensor Cable

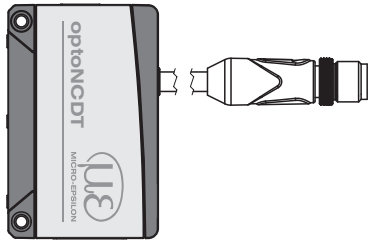

ILD1900 with pigtail

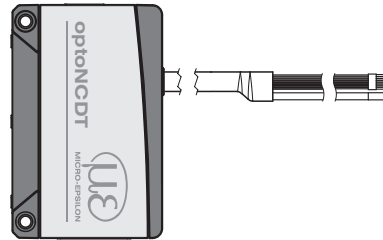

PC1900 with open ends

➡ Never fall below the bending radius for the sensor cable of 30 mm (fixed) resp. 75 mm (dynamic).

i The fixed connected sensor cable is cable carriers suitable.

i Unused open cable ends must be insulated to protect against short circuits or malfunction of the sensor.

Micro-Epsilon recommends to use the cable carriers suitable standard connection cable PC1900 of the optional accessories, see [Chap. A 1](#).

➡ Mount the cable connector if you use a cable carriers suitable sensor cable PC1900.

➡ Avoid excessive pulling to the cables. Provide strain relieves near the connectors when cables > 5 m are vertically free hanging.

➡ Do not twist the connectors in opposite directions when connected.

➡ Connect the cable shield to the potential equalization (PE, protective earth conductor) on the evaluator (control cabinet, PC housing) and avoid ground loops.

➡ Never lay signal leads next to or together with power cables or pulse-loaded cables (e.g. for drive units and solenoid valves) in a bundle or in cable ducts. Always use separate ducts.

6. Operation

6.1 Getting Ready for Operation

- ▶ Install and assemble the optoNCDT 1900 in accordance with the instructions set out, see [Chap. 5](#).
- ▶ Connect the sensor with the indicator or monitoring unit and the power supply.

The laser diode in the sensor can only be activated if at the input Laser on/off Pin 3 is connected with Pin 14, see [Chap. 5.4.4](#).

Once the power supply has been switched on the sensor runs through an initialization sequence. This is indicated by the momentary activation of all the LEDs. Once initialization has been completed, the sensor transmits a „->“ via the RS422 interface. The initialization takes up to 3 seconds. Within this period, only the command reset or the bootloader is executed via the `Select` key.

For reproducible measurements the sensor typically requires a start-up time of 20 minutes.

If the LED `output` is off, this means that there is no supply voltage.

If the LED `state` is off, this means that the laser light source has been switched off.

6.2 Operation via Web Interface

6.2.1 Preconditions

In the sensor a webserver is implemented. The web interface contains among other things the current settings of the sensor and the periphery. The operation is only possible as long as an RS422 connection to the sensor exists.

The sensor is connected to a PC/notebook e. g. via a RS422 converter, supply voltage persist.

sensorTOOL by Micro-Epsilon is a piece of software that you can use to apply settings to the sensor and to view and document measurement data.

You can find it online at <https://www.micro-epsilon.com/download/software/sensorTOOL.exe>.

▶ Start the program `sensorTOOL`.

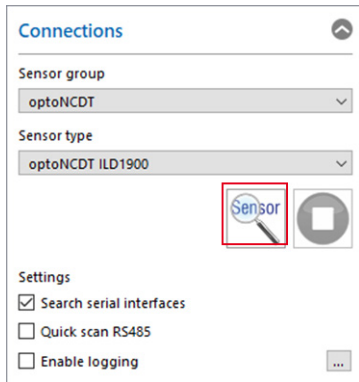

▶ Click the button `Sensor`.

The program searches for connected ILD1900 sensors on available interfaces.

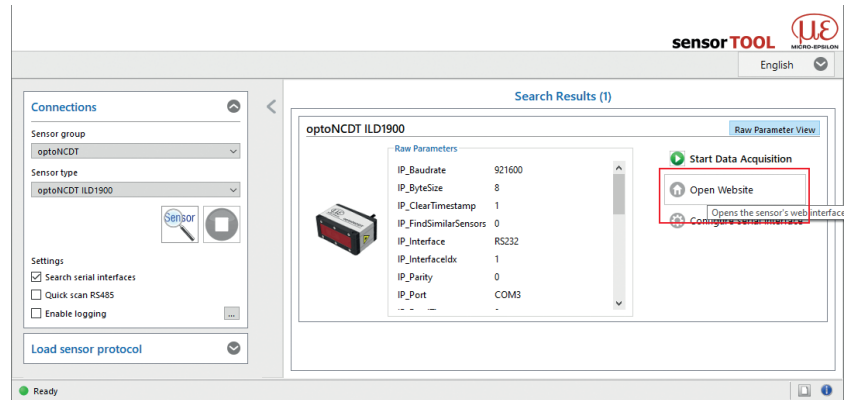

You need a web browser compatible with HTML5 on a PC/notebook.

▶ Choose the desired sensor. Click on the button `Open Website`.

Fig. 29 Auxiliary program for sensor search and to start web interface

6.2.2 Access via Web Interface

▶ Start the web interface of the sensor, see [Chap. 6.2.1](#).

Interactive web pages you can use to configure the sensor are now displayed in the web browser. The sensor is active and supplies measurement values.

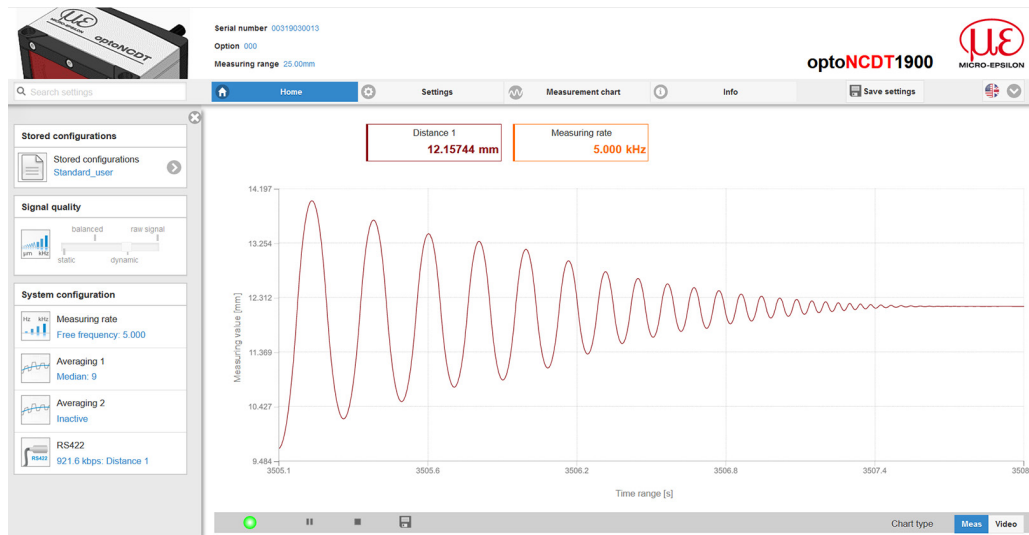





The horizontal navigation includes the functions below:

- The search function permits time-saving access to functions and parameters.
- Home. The web interface automatically starts in this view with measurement chart, Configuration and Signal quality.
- Settings. This menu includes all sensor parameters, see [Chap. 7](#).
- Measurement chart. Measurement chart with digital display or overlay of the video signal.
- Info. Includes information about the sensor, such as serial number, software status and an overview of all sensor parameters.
- Web interface language selection

Fig. 30 First interactive website after selection of the web interface

The appearance of the websites can change dependent of the functions. Dynamic help text with excerpts from the operating instructions supports you during sensor configuration.

i Depending on the selected measuring rate and the PC used, measured values may be reduced dynamically in the display. That is, not all measured values are transmitted to the web interface for display and saving.

| System configuration | |
|--|---------------------------------|
|  | Measuring rate 4.000 kHz |
|  | Averaging 1 Median: 9 |
|  | Averaging 2 Inactive |
|  | RS422 921.6 kbps: Distance 1 |

The area `System configuration` in the Home tab displays the current settings for measuring rate, averaging and RS422 in blue lettering.

The area `Diagram type` enables the change between graphical display of the measurement value or the video signal, each as value time diagram.

6.3 Presets, Setups, Measurement Configuration

Definition

- Preset: Manufacturer-specific program with settings for frequent measuring tasks; cannot be overwritten. Presets are available for the measuring ranges 2, 6, 10, 25 and 50 mm.
- Setup: User-specific program with relevant settings for a measuring task.
- Initial setup at boot (sensor start): a favorite can be selected from the setups, which is automatically activated at sensor start. If no favorite is determined from the setups, the sensor activates the Standard preset at startup.

With delivery of the sensor from the factory

- the presets Standard, Multi-Surface and Light penetration are possible,
- no setup is available.

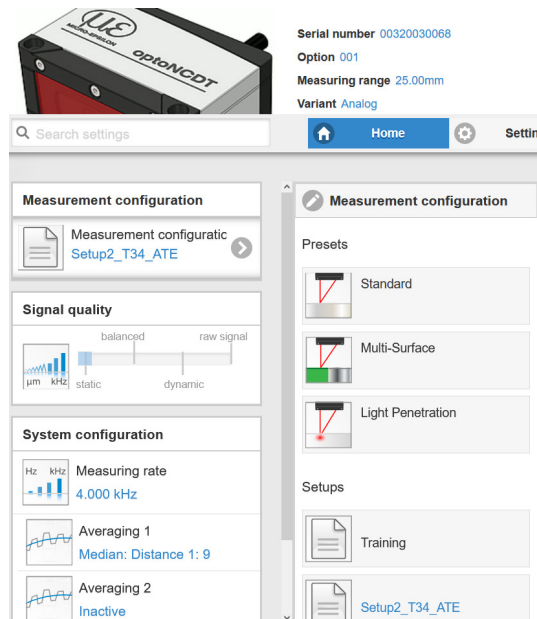

Serial number 00320030068
 Option 001
 Measuring range 25.00mm
 Variant Analog

Search settings

Home Settings

Measurement configuration

Measurement configuratic
Setup2_T34_ATE

Signal quality

balanced raw signal
 μm kHz static dynamic

System configuration

Hz kHz Measuring rate
4.000 kHz

Averaging 1
Median: Distance 1: 9

Averaging 2
Inactive

Measurement configuration

Presets

Standard

Multi-Surface

Light Penetration

Setups

Training

Setup2_T34_ATE

You can select a preset in the tab

- Home > Measurement configuration or
- Settings in the Data acquisition > Measuring task menu.

You can select a setup in the tab

- Home > Measurement configuration or
- Settings in the System settings > Load & Save > Saved measurement setting menu.

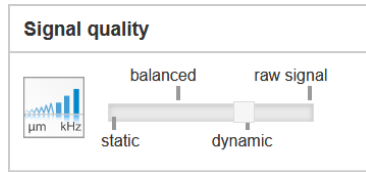

Eight setups can be stored permanently in the controller, see [Chap. 7.7.4](#).

For all presets, the averaging can be individually adapted to the measurement task via the `Signal quality` slider.



| Averaging | Description |
|---|--|
| Balanced Median with 9 values + Moving with 64 values | In the area <code>Signal quality</code> you can switch between four given basic settings (static, balanced, dynamic and no averaging). You can instantly see the reaction in the diagram and system configuration. |
| Raw signal, no averaging | <p>i If the sensor starts with user defined measurement setting (setup), see Chap. 7.7.4, changing the signal quality is not possible.</p> |
| Static Median with 9 values + Moving with 128 values | |
| Dynamic Median, 9 values | |

Presets enable to quickly start the respective measurement task. Choosing a preset suitable to the target surface causes a predefined configuration of the settings which achieves the best results for the chosen material.

| Stored configurations | | |
|--|--------------------------------|--|
| Presets | | |
|  | Standard | Standard Ceramics, metal |
|  | Multi-Surface ¹ | Printed circuit boards (PCB), hybrid material |
|  | Light penetration ¹ | Plastics (Teflon, POM), materials with large penetration depth of the laser |

1) Available for ILD1900-10/25/50 sensors

i After parametrization all the settings are to be stored permanently in a set of parameters. The next time you turn on the sensor they are available again. Therefore use the button `Save settings`.

6.4 Measurement Presentation via Web Browser

▶ Start the measurement value display with the tab `Measurement chart` in the horizontal navigation bar.

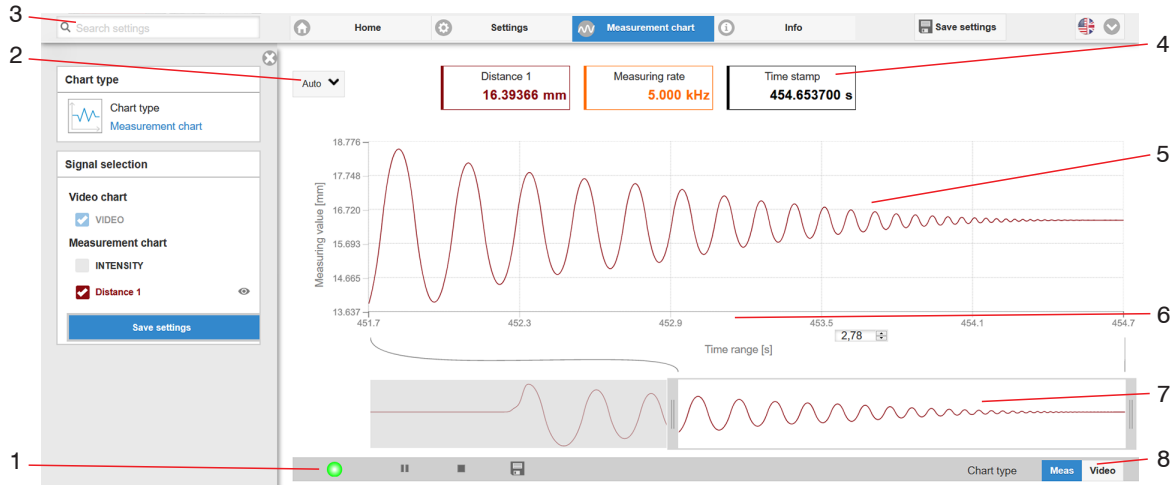

Fig. 31 Website measurement (distance measurement)

- 1 The LED visualizes the status of the transmission of measured values:
 - green: transmission of measured values is running.
 - yellow: waiting for data in trigger mode
 - gray: transmission of measured values stopped

Data queries are controlled by using the `Play/Pause/Stop/Save` buttons of the measured values that were transmitted.

`Stop` stops the diagram; data selection and zoom function are still possible. `Pause` interrupts recording. `Save` opens the Windows selection dialog for file name and storage location to save the last 10,000 values in a CSV file (separation with semicolon).

▶ Click the button ▶ (Start), for starting the display of the measurement results.

- 2 For scaling the measurement value axis (y-axis) of the graphics you can either choose `Auto` (= autoscaling) or `Manual` (= manual setting).
- 3 The search function enables time-saving access to functions and parameters.
- 4 In the text boxes above the graphics current values for distance, current measuring rate and timestamp are displayed.
- 5 Mouse over function. When moving the mouse over the graphic in stopped state curve points are marked with a circle symbol and the related values are displayed in text boxes above the graphic. Peak intensity is also updated.
- 6 Scaling of the x-axis can be defined by means of a input field below the time axis.
- 7 Scaling of the x-axis: you can enlarge (zoom) the overall signal by means of the left slider during ongoing measurement. If the diagram is stopped, you can also use the right slider. The zoom window can also be moved by means of the mouse in the middle of the zoom window (arrow cross).
- 8 Choice of a diagram type: measurement or video signal representation.

6.5 Video Signal via Web Browser

▶ Start the video signal display with the function `Video` in the area `Diagram` type.

The diagram in the big graphic window on the right displays the video signal of the recipient filed. The video signal in the graphic window displays the intensity distribution above the pixels of the recipient field.

0 % (distance small) on the left and 100 % (distance big) on the right. The related measurement value is marked by means of a vertical line (peak marking).

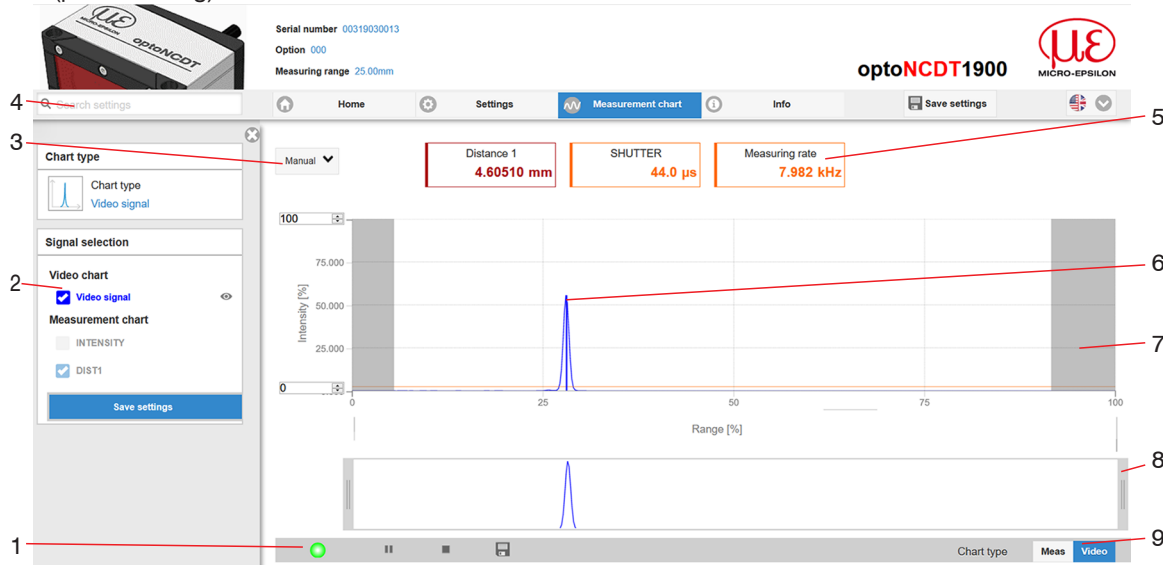

Fig. 32 Display of video signals

1 The LED visualizes the status of the transmission of measured values:

- green: transmission of measured values is running.
- yellow: waiting for data in trigger mode
- gray: transmission of measured values stopped

Data queries are controlled by using the `Play/Pause/Stop/Save` buttons of the measured values that were transmitted.

`Stop` stops the diagram; data selection and zoom function are still possible. `Save` opens the Windows selection dialog for file name and storage location to save the video signal in a CSV file.

 Click the button  (Start), for starting the display of the video signal.

2 The video curves to be displayed while or after measurement can be switched on or off. Non active curves are highlighted in gray and can be added by clicking the hook. If you only want to see a single signal, then click on its name.

- Peak marking (vertical blue line), corresponds to the calculated measurement value
- Linearized measuring range (limited by means of gray shading), cannot be changed
- Masked range (limited by means of light blue shading), changeable

3 For scaling the measurement value axis (y-axis) of the graphics you can either choose `Auto` (= auto scaling) or `Manual` (= manual setting).

4 The search function enables time-saving access to functions and parameters.

 ASCII commands to the sensor can also be sent via the search function.

5 In the text boxes above the graphics current values for distance, exposure time and current measuring rate are displayed.

6 Mouse over function. When moving the mouse over the graphic in stopped state curve points are marked with a circle symbol and the related intensity is displayed. The related x position in % appears above the graphic filed.

7 The linearized range is between the gray shading in the diagram and cannot be changed. Only peaks which centers are within this range can be calculated as measurement value. The masked range can be limited on request and is additionally limited by means of a light blue shading on the right and on the left. The remaining peaks in the resulting range are used for evaluation.

- 8 Scaling of the x-axis: you can enlarge (zoom) the overall signal by means of the left slider during ongoing measurement. If the diagram is stopped, you can also use the right slider. The zoom window can also be moved by means of the mouse in the middle of the zoom window (arrow cross).
- 9 Choice of a diagram type: measurement or video signal representation.

By displaying the video signal, you can detect effect of the adjustable measurement task (target material), choice of peak and possible interfering signals by means of reflections.

There is no linear relationship between the position of the peaks in the video signal and the output measurement value.

6.6 Parametrization via ASCII Commands

As an added feature you can parametrize the sensor via an ASCII interface, physically the RS422. This requires, that the sensor must be connected either to a serial RS422 interface via a suitable interface converter, see [Chap. A 1](#), or a plug-in-card to a PC / PLC.

Pay attention in the programs used to the correct RS422 default setting.

Once connected, you can transmit the commands via the terminal to the sensor, see [Chap. A 4](#).

6.7 Timing, Measurement Value Flux

The sensor requires four cycles for measurement and calculation without triggering:

Each cycle takes $100\ \mu\text{s}$ at a measuring rate of 10 kHz. The measured value N is available at the output after four cycles. The delay between acquisition and output is therefore $400\ \mu\text{s}$. As the processing in the cycles occurs parallel, after another $100\ \mu\text{s}$, the next measured value (N+1) is output.

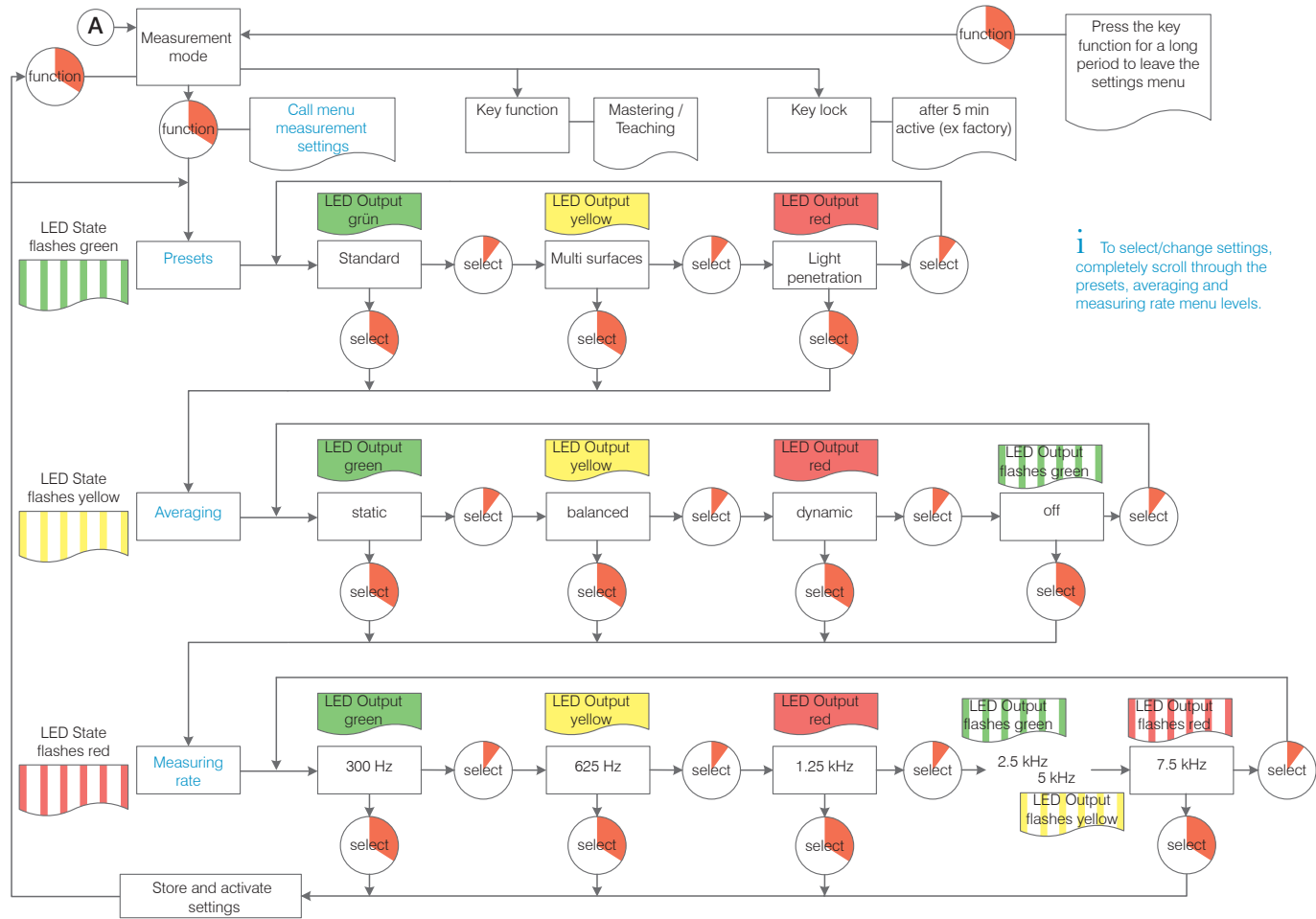

7. Setting Sensor Parameters

7.1 Preliminary Remarks about the Setting Possibilities

There are different ways to parametrize the optoNCDT 1900:

- using the web browser and the sensor web interface
- using the ASCII command set and the terminal program via RS422

i

If the parametrization is not permanently stored on the sensor, the settings will be lost after switching off the sensor.

7.2 Overview Parameter

The following parameters can be set or changed in the optoNCDT 1900, see tab *Settings*.

| | |
|-------------------|--|
| Inputs | Laser power, Synchronization, Multi-function input, Termination |
| Data recording | Measurement task, Measuring rate, Input trigger, Evaluation range, Exposure mode, Peak selection, Error handling |
| Signal processing | Averaging 1/2, Zeroing/Mastering, Output trigger, Data reduction |
| Outputs | RS422, Analog output, Digital outputs (Switching outputs), Output interface |
| System settings | Unit on web interface, Key lock, Load & Save, Import & Export, Access authorization, Reset sensor (factory settings) |

7.3 Inputs

➤ Change to the **Input** menu in the **Settings** tab.

| | | | |
|----------------------------|------------------------------------|--|--|
| Laser power | <i>Full</i> | <i>Full power for standard surfaces</i> | <i>The laser light source is active only, if pin 3 is connected to GND (pin 14).</i> |
| | <i>Medium ¹</i> | <i>Optimized power for strongly reflective surfaces and small measuring ranges</i> | |
| | <i>Reduced</i> | <i>Minimum power for service</i> | |
| | <i>Off</i> | <i>Laser is off</i> | |
| Synchronization | <i>Slave / Slave alternating</i> | <i>If several sensors measure the same target synchronously, the sensors may be synchronized with each other. The synchronization output of the first sensor (master) controls the sensors connected to the synchronization inputs (slaves).</i> | |
| | <i>Slave MFI</i> | | |
| | <i>Master / Master alternating</i> | | |
| | <i>inactive</i> | | |
| Level Multi-function input | <i>TTL / HTL</i> | <i>Defines the input level of both switching inputs Laser on/off and Multi-function.</i> <i>TTL: Low ≤ 0,8 V; High ≥ 2 V</i> <i>HTL: Low ≤ 3 V; High ≥ 8 V</i> | |
| Termination | <i>On / Off</i> | <i>For synchronization, the terminating resistor at 120 Ohm in the last slave must be enabled.</i> | |

I Pay attention to the signal intensity when switching the laser power. You achieve best possible results with a signal intensity of 25 ... 50 %.

1) The Medium laser power function is only available from firmware 004.004.

 Grey shaded fields require a selection.

 *Value* Fields with dark border require entry of a value.

7.3.1 Synchronization via Sync +/- Connections

If two sensors measure against the same target, the sensors can be synchronized. The optoNCDT 1900 distinguishes between two types of synchronization.

| Type | | Used for |
|------------------------------|--|--|
| Simultaneous synchronization | Both sensors measure in the same cycle | Measurement of differences (thickness, difference in height) on opaque objects. Here, Sensor 1 must be programmed as the “Master” and Sensor 2 as the “Slave”, see Chap. 7.3 . |
| Alternating synchronization | Both sensors measure alternatively Output rate ≤ measuring rate / 2 | Thickness measurements on translucent objects or measurements of difference on closely spaced measurement points. The alternating synchronization requires that the lasers are switched on and off alternately so that the two sensors do not interfere with each other optically. Therefore one sensor is to program as “Master alternating” and one as “Slave alternating”. There can be only one master to be connected to a slave. |

Fig. 33 Characteristics of and uses for the different types of synchronization

NOTICE

The synchronous connections may not be temporarily connected to the power supply and / or GND. Risk of destruction of the sensor by overloading.

Sensor simultaneously synchronizes other sensors

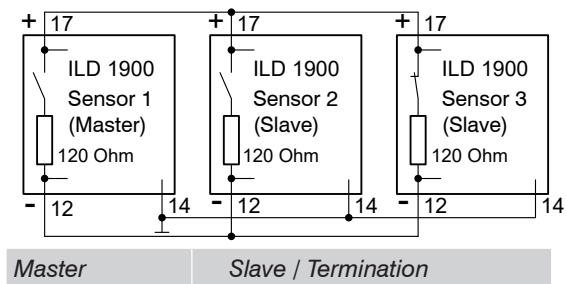

The signals Sync-in/out or /Sync-in/ of same polarity are connected in parallel with each other. A sensor is to program as a synchronous master, which supplies the subsequent slave sensors with symmetric synchronous pulses, RS422-level. Only in the last slave sensor in the chain the terminating resistor is activated of 120 Ohm, see [Chap. 7.3](#).

The system grounds (pin 14) of the sensors are to connect to each other. Settings in the `Inputs > Synchronization` menu, see [Chap. 7.3](#).

Fig. 34 Sensor 1 synchronizes other sensors

Sensor alternately synchronizes another sensor

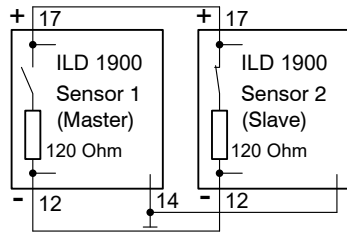

The signals Sync-in/out or /Sync-in/ of same polarity are connected in parallel with each other. A sensor is to program as a synchronous master, which supplies the subsequent slave sensor with symmetric synchronous pulses, RS422-level. In the slave sensor the terminating resistor is activated of 120 Ohm, see [Chap. 7.3](#). The system grounds (pin 14) of the sensors are to connect to each other.

Master alternating *Slave alternating / Termination*

Settings in the `Inputs > Synchronization` menu, see [Chap. 7.3](#).

Fig. 35 Sensor 1 synchronizes another sensor

i Do not ever connect two masters with each other. If two masters are connected to one another, the laser diodes switch off. No measurement is possible.

| Signal | Pin | Description | Color sensor cable PC1900-x | |
|--------|-----|--|-----------------------------|---|
| GND | 14 | System ground for power supply, switch signals (Laser on/off, Zero, Limits) | Blue | <p>17-pin connector, M12, pin side male cable connector pigtail</p> |
| Sync + | 17 | Symmetrical synchron output (Master) or input (Slave) | Grey-pink | |
| Sync - | 12 | | Red-blue | |
| | | RS422 level, terminating resistor 120 Ohm switchable, input or output selected depending on the synchronization mode | | |

Fig. 36 Extract pin assignment

7.3.2 Synchronization via Multi-Function Input

i Do not ever connect two masters with each other. If two masters are connected to one another, the laser diodes switch off. No measurement is possible.

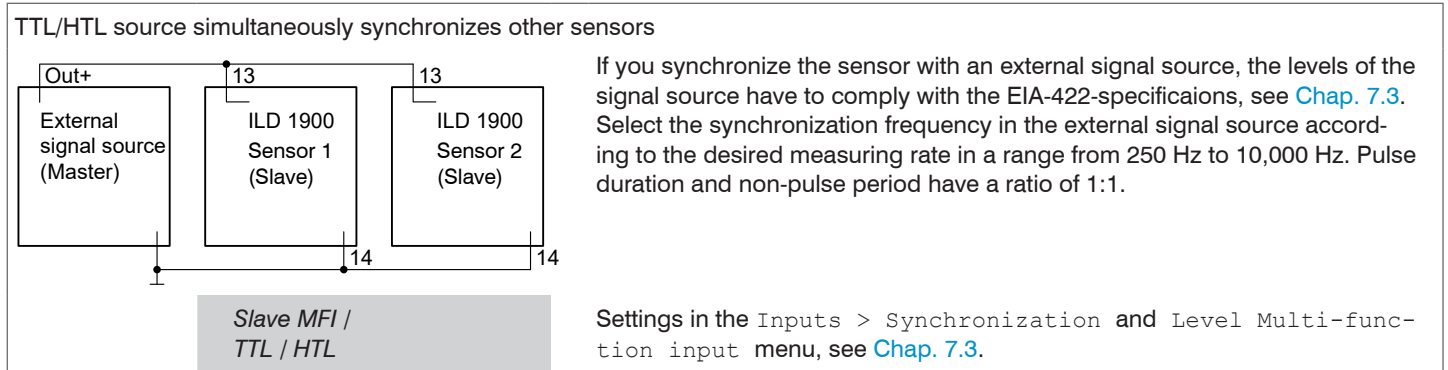

Fig. 37 Signal source synchronizes sensors

| Signal | Pin | Description | | Color sensor cable PC1900-x |
|----------------------|-----|---|--|-----------------------------|
| GND | 14 | System ground for power supply, switch signals (Laser on/off, Zero, Limits) | | blue |
| Multi-function input | 13 | Switching input | TrigIn, Zero/Master, TeachIn, SlaveIn, see Chap. 5.4.6 | violet |

17-pin connector, M12, pin side male cable connector pigtail

Fig. 38 Extract pin assignment

7.4 Data Recording

7.4.1 Preliminary Remark

➡ Change to the `Data recording` menu in the `Settings` tab .

According to the previous setting in the `Diagram type` area, a diagram is displayed in the right part of the display. The diagram is active and all settings become immediately visible. Notes on the chosen settings are displayed below.

In the left area, the menus for the `Data recording` are displayed.

7.4.2 Measurement Configuration

Details can be found in `Operation via Web Interface`, see [Chap. 6.3](#).

7.4.3 Measuring Rate

The measuring rate indicates the number of measurements per second.

➡ Select the required measuring rate.

| | | |
|----------------|---|---|
| Measuring rate | 250 Hz / 500 Hz / 1 kHz / 2 kHz / 4 kHz / 8 kHz / 10 kHz | Use a high measuring rate for bright and mat measurement objects. Use a low measuring rate for dark or shiny measurement objects (e.g. black painted surfaces) to improve the measurement result. |
| | Free measuring rate Value | |

At a maximum measuring rate of 10 kHz, the CMOS element is exposed 10,000 times per second. The lower the measuring rate, the longer the maximum exposure time.

The measuring rate is factory set to 4 kHz.

 Grey shaded fields require a selection.

 Value Fields with dark border require entry of a value.

7.4.4 Triggering

7.4.4.1 General

The value input and output on the optoNCDT 1900 can be controlled through an external electrical trigger signal or commands. Both analog and digital outputs (switching outputs) are affected. The measured value to the trigger point is output delayed, see [Chap. 6.7](#).

- Triggering does not influence the preset measuring rate or the timing so that 4 cycles + 1 cycle (jitter) are between the trigger event (level change) and the output reaction
- Micro-Epsilon does not recommend any data reduction e.g. by subsampling when the trigger is used.
- The multi-function or synchronization inputs are used as external trigger inputs, see [Chap. 5.4.6](#).
- Factory settings: no triggering, the sensor starts transmitting data output as soon as it is switched on.
- “Trigger in” pulse duration is at least 50 μ s.

The triggering of the measured value recording and output have the same timing.

| | | | | | | |
|----------------|--|---------------------------|-------------------------------------|-------|--------------------------------|--|
| Input trigger | Multi-function input / Synchronization input | Trigger type | Edge / Level | | | |
| | | Trigger level | high rising edge / low falling edge | | | |
| Output trigger | Synchronization input | Number of measured values | Infinite | | | |
| | | | Manual selection | Value | Range: 1 ... 16383 | |
| Trigger source | Software | Number of measured values | Infinite | | | |
| | | | Manual selection | Value | Range: 1 ... 16383 | |
| | | Start triggering | | | Button starts data recording | |
| | | Stop triggering | | | Sensor outputs continuous data | |
| Inactive | | No triggering | | | | |

Valid with triggering: $f_T < f_M$

f_T Trigger frequency

f_M Measuring rate

 Grey shaded fields require a selection.

 Value Fields with dark border require entry of a value.

Implemented trigger conditions:

Level triggering with High level / Low level.

Continuous value input/output for as long as the selected level is active. Then the data recording/output stops.

Pulse duration must last for at least one cycle.

The subsequent pause must also last for at least one cycle.

U_1 = Trigger signal

W = Displacement signal

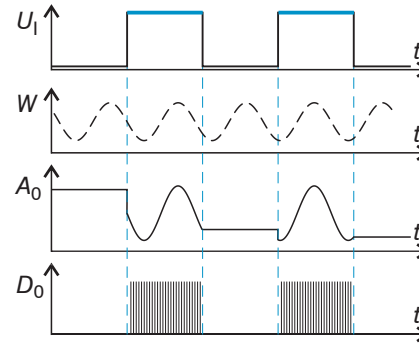

Fig. 39 Trigger level High (above) with analog output A_0 and digital output signal D_0 (below).

Edge triggering with rising or falling edge.

Starts data recording as soon as the selected edge is active to the trigger input. If trigger conditions are met, the sensor outputs a defined number of measurements.

Value range between 1 ... 16382. After completion of data output the analog output remains standing at the last value.

The duration of the pulse must be at least 50 μ s.

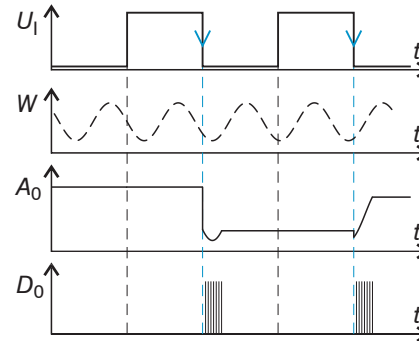

Fig. 40 Trigger edge HL (above) with analog output A_0 and digital output signal D_0 (below).

Software triggering. Data recording is caused by the TRIGGERSW SET command. The sensor outputs the previously set number of measured values or initiates a continuous measured value output after the trigger event. Measurement value output can also be stopped via a command.

7.4.4.2 Triggering Data Recording

The data recording trigger processes measurements which are recorded from the trigger event. Previously acquired measurement values are rejected. The record triggering therefore directly influences the subsequent processing of measured values. In particular, the average calculation only includes values measured from the trigger event.

Activating the data recording trigger deactivates the data output trigger.

7.4.4.3 Triggering Data Output

Measurement values are calculated continuously and independently of the trigger event. A trigger event simply triggers the value output via a digital or an analog interface. Therefore, any values measured immediately before the trigger event are included in calculating mean values (averages).

Activating the data recording trigger deactivates the data recording trigger.

7.4.5 Masking the Evaluation Range, ROI

Masking limits the evaluating range (ROI - Region of Interest) for the distance calculation in the video signal. This function is used in order to e.g. suppress interfering reflections or ambient light.

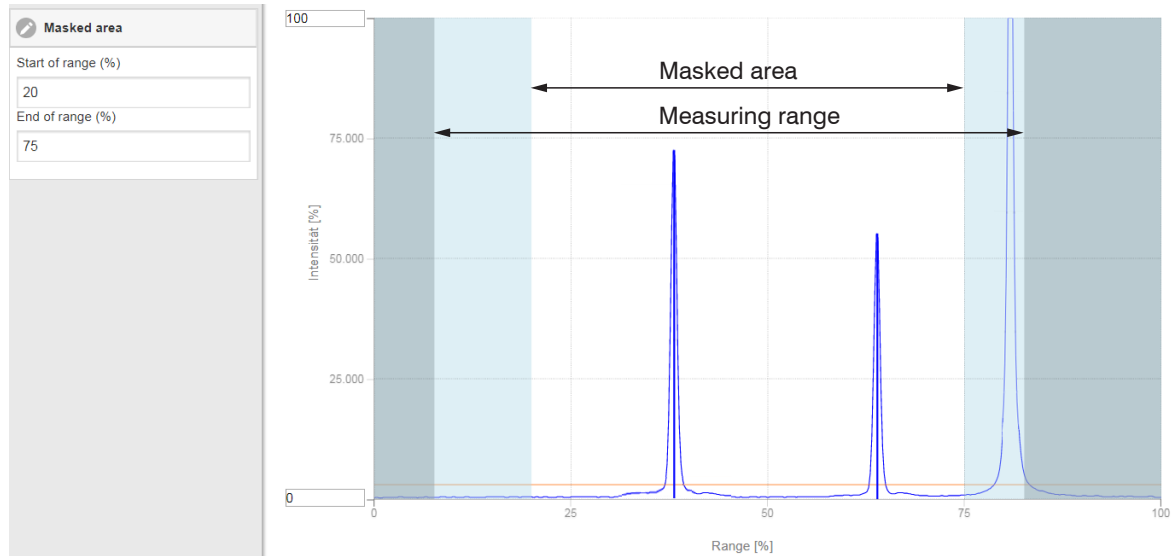
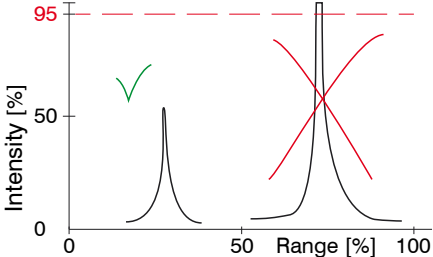

Fig. 41 Light blue areas limit the evaluation range

The exposure control optimizes the peaks in the evaluation range. Therefore, small peaks can be optimally adjusted when a high interference peak is outside the evaluation range.

7.4.6 Exposure Mode

| | | | | |
|---------------|----------------|---|-------|---|
| Exposure mode | Automatic mode | Standard / Intelligent control / Background suppression | |  <p><i>Standard: The sensor automatically determines the optimum exposure time and regulates the intensity to approx. 50-60%.</i></p> <p><i>Intelligent control: the intelligent control algorithm is beneficial when measuring moving objects or material transitions.</i></p> <p><i>Background suppression: suppresses interferences caused by ambient light which greatly increases the sensor's ambient light tolerance. This reduces the sensor's output rate by half.</i></p> |
| | Manual mode | Exposure time in μs | Value | |

Grey shaded fields require a selection.

Value Fields with dark border require entry of a value.

7.4.7 Peak Selection

| | | | |
|----------------|--|---|--|
| Peak selection | <i>First peak / Highest peak / Last peak / Widest peak</i> | <p><i>Defines which signal is used for the evaluation in the line signal.</i></p> <p><i>First peak: Nearest peak to sensor.</i> <i>Highest peak: standard, peak with the highest intensity.</i> <i>Last peak: widest peak to sensor.</i> <i>Widest peak: peak with maximum area.</i></p> | |
|----------------|--|---|--|

If a measurement object contains multiple transparent layers, a correct measurement result is determined only for the first peak.

7.4.8 Error Processing

The error processing controls the behavior of the analog output and the RS422 interface in the event that an error occurs.

| | | | |
|----------------|---------------------------------|---|-------|
| Error handling | <i>Digital output, no value</i> | <i>The analog output supplies 3 mA resp. 5.2 / 10.2 V instead of measurement value. The RS422 interface outputs an error value.</i> | |
| | <i>Hold last value infinite</i> | Analog output and RS422 interface stop at the last valid value. | |
| | <i>Hold last value</i> | 1 ... 1024 | Value |

If no valid reading can be obtained, an error is issued. Should this be a problem for processing, the last valid value can be hold for a certain period of time, and will be issued repeatedly. After this period has expired, an error value is output.

1) Amount of measurement cycles which output the last valid measurement. Then an error value is output.

Grey shaded fields require a selection.

Value Fields with dark border require entry of a value.

7.5 Signal Processing

7.5.1 Preliminary Remark

➡ Change to the `Signal processing` menu in the `Settings` tab.

According to the previous setting in the `Diagram type` area, a diagram is displayed in the right part of the display. The diagram is active and all settings become immediately visible. Notes on the chosen settings are displayed below.

In the left area, the menus for the `signal processing` area are displayed.

7.5.2 Averaging

7.5.2.1 General

Averaging is recommended for static measurements or slowly changing measured values.

The function `Averaging 1` is done before `Averaging 2`.

| | | | | |
|-----------|---------------------------|--------------------|--------------|--|
| Averaging | <i>Inactive</i> | | | <i>Measurement values are not averaged.</i> |
| | <i>Moving N values</i> | 2 / 4 / 8 ... 4096 | <i>Value</i> | <i>Indication of averaging mode. The averaging number N indicates the number of consecutive measurement values to be averaged in the sensor.</i> |
| | <i>Recursive N values</i> | 2 ... 32000 | <i>Value</i> | |
| | <i>Median N values</i> | 3 / 5 / 7 / 9 | <i>Value</i> | |

Measurement averaging is performed after the distance values have been calculated, and before they are issued through the relevant interfaces.

Averaging

- improves the resolution,
- allows masking individual interference points, and
- 'smoothes' the reading.

Linearity is not affected by averaging.

The average values are continuously recalculated with each measurement. The desired averaging depth is only achieved after the number of recorded measurement values corresponds at least to the averaging depth.

 Grey shaded fields require a selection.

 *Value* Fields with dark border require entry of a value.

i The defined type of average value and the averaging number must be stored in the sensor to ensure they are hold after it is switched off.

Averaging has no effect on the measuring rate or data rate in case of digital measurement value output. The averaging numbers can also be programmed via the digital interfaces. The optoNCDT 1900 sensor is delivered with “Median 9” as factory settings, i.e. median averaging over 9 measurement values.

Depending on the type of average and the number of averaged values, different transition response times result thereof, see Chap. 6.4.

7.5.2.2 Moving Average

The definable number N for successive measurements (window width) is used to calculate the arithmetic average M_{mov} according to the following formula:

$$M_{\text{mov}} = \frac{\sum_{k=1}^N MV(k)}{N}$$

| | |
|------------------|---|
| MV | Measurement value, |
| N | Averaging number, |
| k | Running index |
| M_{mov} | Averaging value respectively output value |

Methods:

Each new measured value is added, and the first (oldest) value is removed from the averaging (from the window). This produces short response times for measurement jumps.

Example: $N = 4$

| | | |
|---|--|--------------------|
| $\dots 0, 1, \underline{2}, \underline{2}, 1, 3,$ | $\dots 1, 2, \underline{1}, \underline{2}, 1, 3, 4,$ | Measurement values |
| \downarrow | \downarrow | |
| $\frac{2, 2, 1, 3}{4} = M_{\text{mov}}(n)$ | $\frac{2, 1, 3, 4}{4} = M_{\text{mov}}(n+1)$ | Output value |

Special features:

Moving average in the optoNCDT 1900 allows only potentials of 2 for N .

Range of values for averaging number N is 1 / 2 / 4 / 8 ... 4096.

7.5.2.3 Recursive Average

Formula:

$$M_{\text{rek}}(n) = \frac{MV_{(n)} + (N-1) \times M_{\text{rek}(n-1)}}{N}$$

| | |
|------------------|---|
| MV | Measurement value, |
| N | Averaging number, |
| n | Measurement value index |
| M_{rek} | Averaging value respectively output value |

Methods:

The weighted value of each new measured value $MV(n)$ is added to the sum of the previous average values $M_{\text{rec}}(n-1)$.

Special features:

Recursive averaging allows for very strong smoothing of the measurements, however it requires long response times for measurement jumps. The recursive average value shows low-pass behavior. Range of values for the averaging number N is 1 ... 32000.

7.5.2.4 Median

A median value is formed from a preselected number of measurements.

Methods:

The incoming measured values (3, 5, 7 or 9 measurement values) are also sorted again after each measurement. Then, the average value is provided as the median value. 3, 5, 7 or 9 measured values are taken into account for the calculation of the median, i.e. there is no median 1.

Special features:

This averaging type suppresses individual interference pulses. However, smoothing of the measurement curves is not very strong.

Example: average value from five readings

... 0 1 2 4 5 1 3 → Sorted measurement values: 1 2 3 4 5 Median_(n) = 3

... 1 2 4 5 1 3 5 → Sorted measurement values: 1 3 4 5 5 Median_(n+1) = 4

7.5.3 Zeroing and Mastering

By zeroing and mastering you can set the measurement value to a set point in the measuring range. The output range is moved thereby. This function makes sense, for example, for several adjacent measuring sensors or in the case of the thickness and planarity measurement.

| | | | |
|-----------------------|----------|---|---|
| Zeroing/ Mastering | Inactive | <i>Normal measurement value or Zeroing/Mastering is undone.</i> | |
| | Active | Value | <i>Indication e. g. of thickness of a master part. Value range max. 0 up to + 2 x measuring range</i> |

Setting masters is used to compensate mechanical tolerances in the measurement setup of the sensors or to adjust the temporal (thermal) changes in the measurement system. The masters measurement, also a known as the calibration measurement, is given a set point.

The value which is given during measurement on the sensor output of the “mastering object“ is the `master value`. The zero-setting is a characteristic of the mastering, because here the master value is 0.

When mastering the sensor’s characteristic is parallel displaced. The displacement of the characteristic curve reduces the usable measurement range of the sensor the further the master value is away from the master position.

Sequence for Mastering / Zeroing:

- ➡ Bring target and sensor in the desired position together.
- ➡ Send the master command.

The master command waits for 2 seconds on the next measurement value and masters it. If no measurement value is received within this time, for example by external triggering, the command returns with the error `E220 Timeout back`.

After the mastering, the sensor gives new measurement values, related to the master value. The non-mastered condition applies by means of a reset with the button `Inactive`.

i `Zeroing/Mastering` requires that a target is within the `measurement range`.
i `Zeroing/Mastering` has an influence on the digital and the analog output.

An invalid master value, e. g. no peak available, will be acknowledged with the `E602 Master value is out of range error`.

 Grey shaded fields require a selection.

 `Value` Fields with dark border require entry of a value.

7.5.3.1 Zeroing, Mastering with Select Key

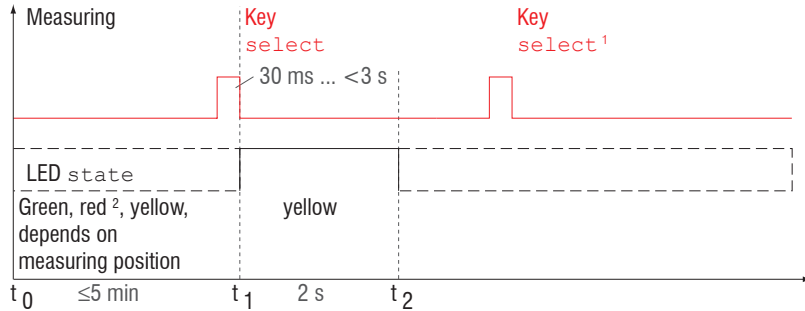

Fig. 42 Flow chart for zeroing, mastering (key select)

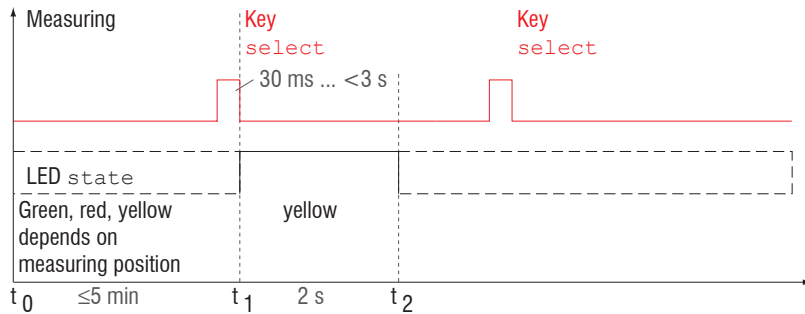

Fig. 43 Flow chart for the return of zero setting and mastering

- 1) The key `Select` remains without effect since key lock is active.
- 2) The master value is not applied when LED State is red, flash frequency 8 Hz for 2 s.

i The key `Select` is locked according to factory settings after expiry of 5 min. You can unlock the keylock e.g. via the web interface, see [Chap. 7.7.3](#).

The function Zeroing/Mastering can be used several times in succession. Between repetition of the function Zeroing/Mastering a brake of 1 s is necessary. The function Zeroing/Mastering can also be combined with the multifunctional input.

7.5.3.2 Zeroing, Mastering with Hardware Input

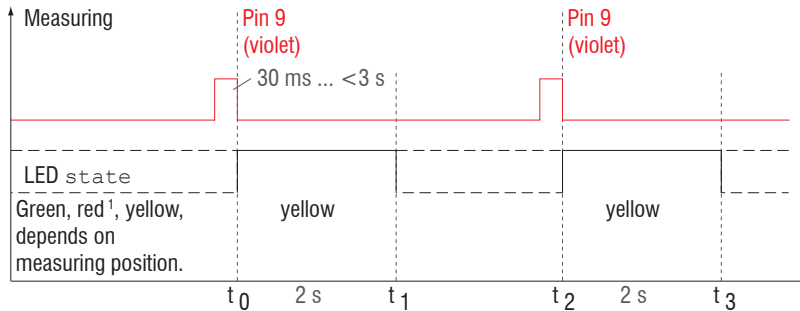

Fig. 44 Flow chart for zeroing, mastering (hardware input)

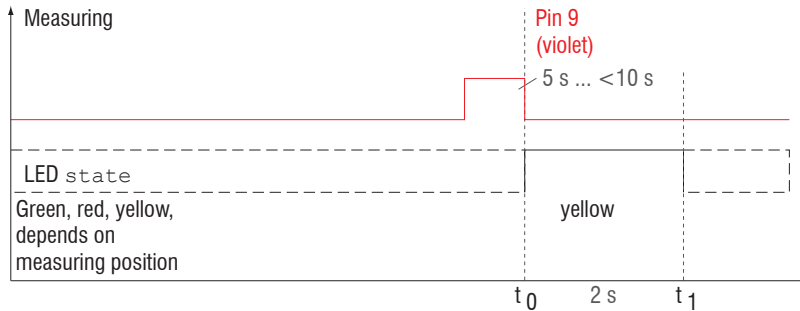

Fig. 45 Flow chart for the return of zero setting and mastering

The function zeroing/mastering can be applied successive in several times. Between repeating the zeroing/mastering function a pause of 1 s is required. The zeroing/mastering function can also be combined with the `select` key.

1) With red State LED, the master value is not accepted, flashes with 8 Hz for 2 s.

i A pulse on the functional input can be made via pin 9 pigtail or via the violet wire on the sensor cable or via the PC1900-x . Details of the hardware input can be found in the electrical connections, see [Chap. 5.4.6](#).

7.5.4 Output Trigger

Details can be found in Triggering, see Chap. 7.5.4.

7.5.5 Data Reduction, Output Data Rate

| | | |
|----------------------|-------------------------------|--|
| Data reduction | <i>Value</i> | <i>Indicates the sensor which data is to be excluded from output, thus the data amount to be transmitted is reduced.</i> |
| Reduction relates to | <i>RS422 / Analog / Chart</i> | <i>Interfaces to be used for undersampling are to be selected via the checkbox.</i> |

You can reduce the measurement output in the sensor if you set the output of every nth measurement value in the web interface or by command. Data reduction causes only every nth measured value to be output. The other measurement values are rejected. The reduction value n can range from 1 (each measurement value) to 3,000,000. This allows you to adjust slower processes, such as a PLC, to the fast sensor without having to reduce the measuring rate.

 Grey shaded fields require a selection.

 *Value* Fields with dark border require entry of a value.

7.6 Outputs

7.6.1 Overview

| | | | | | |
|---|---------------------------|--|-----------|-------|--|
| RS422 | Baud rate | 9.6 / 115.2 / 230.4 / 460.8 / 691.2 / 921.6 / 2000 / 3000 / 4000 kBps | | | Transmission speed, binary data format |
| | Output data | Distance / Non-linearized center of gravity / Intensity / Exposure time / Sensor state / Measuring rate Measurement counter / Time stamp / Video signal | | | |
| Analog output | Output range | 0-5 V / 0-10 V / 4-20 mA | | | Select voltage or current output |
| | Scaling | Standard scale | | | Start of measuring range 0 V oder 4 mA, End of measuring range 5 V/10 V / 20 mA |
| | | Two-point scale | Minimum | Value | |
| | Maximum | | Value | | |
| | Start teaching process | Select button / Multifunctional input / Inactive | | | |
| | | | | | |
| Digital output (switching output) 1 / 2 | Configuration | Full scale error / Distance is outside the analog range / Distance is out of limit | | | Regulates the switching performance of the digital (switching) output (Error), see Chap. 5.4.8 . Range limit values: -2 ... +2 x Measuring range The minimum hold time defines how long the output must be active at least. The hysteresis defines a dead band around the selected limit values. |
| | Compare to limit | Lower / Upper / Both | Limit min | Value | |
| | | | Limit max | Value | |
| | Switching level | NPN / PNP / PushPull / PushPull negative | | | |
| | Minimum hold time | 1 ... 1000 ms | Value | | |
| Hystereses | 0 ... 2 x Measuring range | Value | | | |

| | | |
|------------------|---|---|
| Output interface | RS422 / Analog output / digital output 1 (switching output 1) / digital output 2 (switching output 2) | <i>Defines which interface is used for output of measured values. A parallel output of measured values via multiple channels is not possible. RS422 and analog output cannot be operated simultaneously. The switching outputs 1 and 2 can be activated regardless of any other channel. While using the web interface, the output is switched off via RS422.</i> |
|------------------|---|---|



Grey shaded fields require a selection.



Fields with dark border require entry of a value.

7.6.2 Digital Output, RS422

7.6.2.1 Values, Ranges

The digital measurement values are issued as unsigned digital values (raw values). 16 or 18 bits can be transferred per value. Below you will find a compilation of the output values and the conversion of the digital value.

| Value | Length | Variables | Value range | Formula |
|------------------------|--------|--|--|--|
| Distance | 18 Bit | <i>x</i> digital value | [0; 230604] | $d = \frac{x - 98232}{65536} * MR$ |
| | | <i>MR</i> Measuring range in mm | {10/25/50} | |
| | | <i>d</i> Distance in mm | without mastering [-0.01 <i>MR</i> ; 1.01 <i>MR</i>] with mastering [-2 <i>MR</i> ; 2 <i>MR</i>] | |
| Exposure time | 16 Bit | <i>x</i> digital value | [1000; 40000] | $ET = \frac{1}{10} x$ |
| | | <i>ET</i> Exposure time in μ s | [100; 4000] | |
| Intensity | 16 Bit | <i>x</i> digital value | [0; 1023] | $I = \frac{100}{1023} x$ |
| | | <i>I</i> Intensity in % | [0; 100] | |
| Sensor state | 18 Bit | <i>x</i> digital value | [0; 242143] | Bit 0 (LSB): peak starts before ROI |
| | | Bit coding | [0; 1] | Bit 1: peak ends after ROI |
| | | | | Bit 2: no peak found |
| | | <i>SMR</i> <i>SMR</i> = Start of measuring range | | Bit 5: Distance before <i>SMR</i> (extended) |
| | | <i>EMR</i> <i>EMR</i> = End of measuring range | | Bit 6: Distance after <i>EMR</i> (extended) |
| | | | Bit 15: Measurement value is triggered | |
| | | | Bit 16, 17: Status LED; - 00 – off 10 – red - 01 – green 11 – yellow | |
| Measured Value Counter | 18 Bit | <i>x</i> digital value | [0; 262143] | |

| | | | | | |
|-----------------------------------|-----------------------|----|------------------------|-------------------|-----------------------------------|
| Time Stamp | 2 words, at 16 Bit | x | digital value Lo | [0; 65535] | $t = \frac{1}{1000} (65536y + x)$ |
| | | y | digital value Hi | [0; 65535] | |
| Unlinearized center of gravity | 18 Bit | t | time stamp in μ s | [0; 1h11m34.967s] | $US = \frac{100}{262143} x$ |
| | | x | digital value | [0; 262143] | |
| | | CG | center of gravity in % | [0; 100] | |
| Video signal | 16 Bit | | 512 pixels | [0; 1023] | |
| Measurement frequency | 18 Bit | x | digital value | [2500; 100000] | $f = \frac{x}{10}$ |
| | | f | frequency in Hz | | |

State information transferred in the distance value

| Distance value | Description |
|----------------|--|
| 262075 | Too much data for selected baud rate |
| 262076 | There is no peak present |
| 262077 | Peak is located in front of the measuring range (MR) |
| 262078 | Peak is located after the measuring range (MR) |
| 262080 | Measurement value cannot be evaluated, global error |
| 262081 | Peak is too wide |
| 262082 | Laser is off |

7.6.2.2 Behavior of the Digital Output

Master values based on the zeroing or master function are coded with 18 bits. Master value range: 0 ... 2x measuring range. The examples demonstrate the behavior of the digital value with an ILD1900-100, measuring range 100 mm.

Target with 16 % of the measuring range

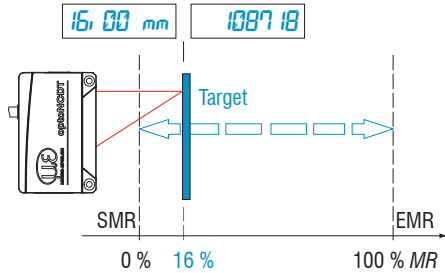

Target with 60 % of the measuring range

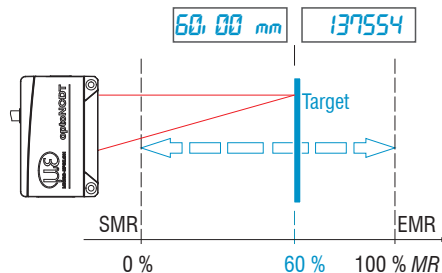

Target with 60 % of the measuring range

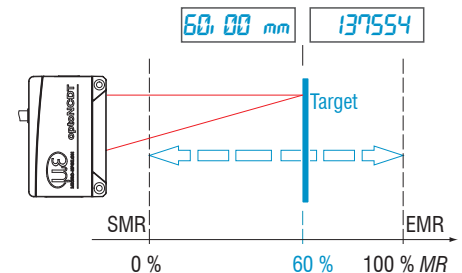

➡ Zero setting (master value = 0 mm)

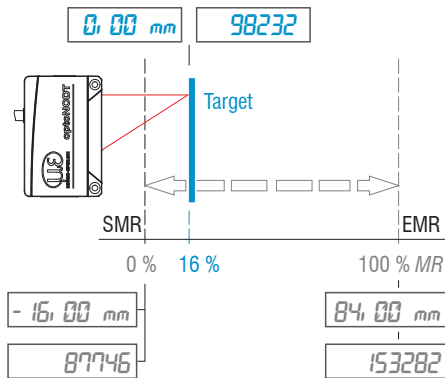

➡ Zero setting (master value = 0 mm)

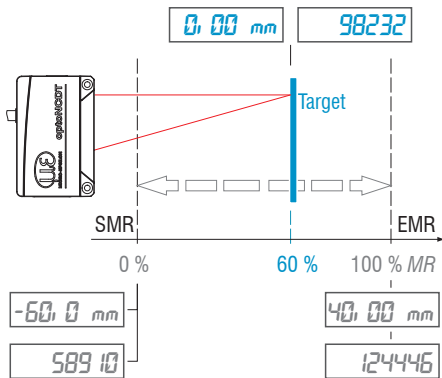

➡ Setting master value 10 mm

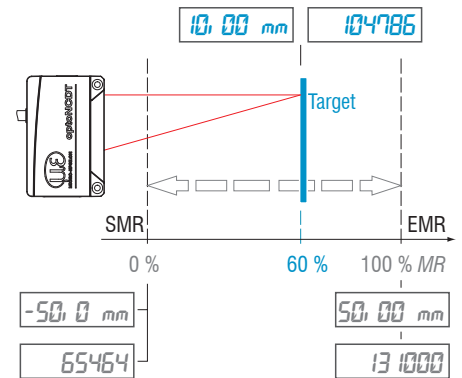

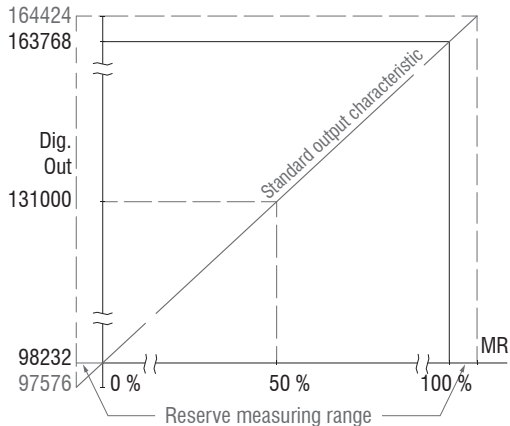

Fig. 46 Digital values without zeroing or mastering

Target with 80 % of the measuring range (80 mm)

➔ Setting master value 200 mm

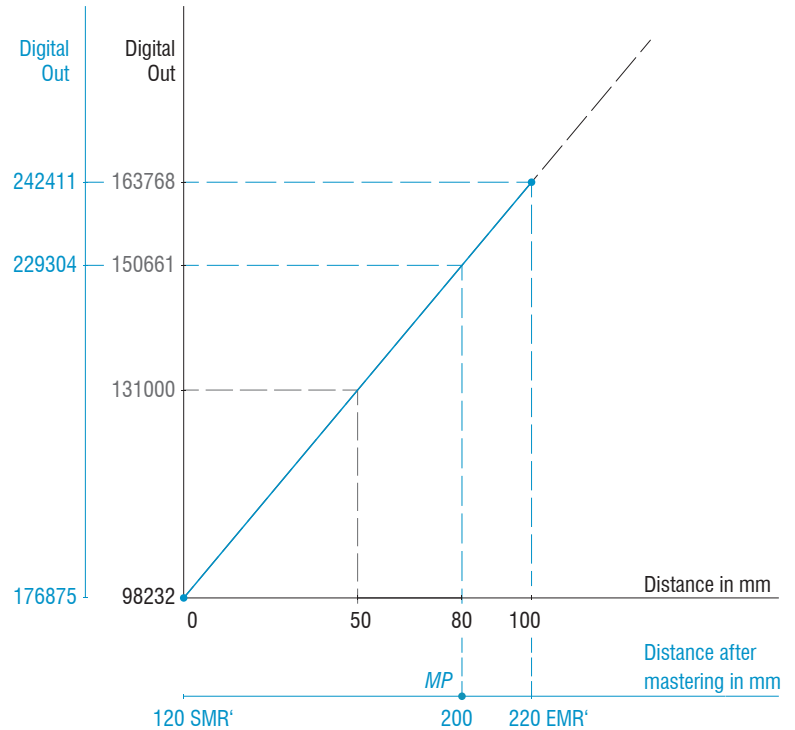

Fig. 47 Digital values ILD1900-100 after mastering with 200 mm

7.6.3 Analog Output

7.6.3.1 Output Scaling

- Max. output range: 4 mA ... 20 mA or 0 V ... 5 V / 0 V ... 10 V
- Output amplification ΔI_{OUT} : 16 mA or ΔV_{OUT} : 5 V / 10 V; corresponds to 100 % MR
- Error value: 3.0 mA ($\pm 10 \mu A$) or 5.2 V or. 10.2 V

Teaching scales the analog output. This allows you to optimize the resolution for the analog output. The behavior of the analog and switching outputs will change. In every case, 2 points are taught which characterize the start and the end of the new measuring range. The teaching is performed via the built-in **Select** button, the multi-function input, ASCII command or via web interface.

i In conjunction with a user-specific output characteristic, you can use the switching outputs, see [Chap. 5.4.8](#), as movable limit switches.

The target position for **Teach 1** and **Teach 2** must be different. The teaching process requires a valid measurement signal. In case of

- no object, object cannot be evaluated,
- too close to the sensor - outside the SMR, or
- too far from the sensor - outside the EMR

the teaching process is aborted.

Fig. 48 Standard characteristic (black), reversed, user-specific characteristic (red)

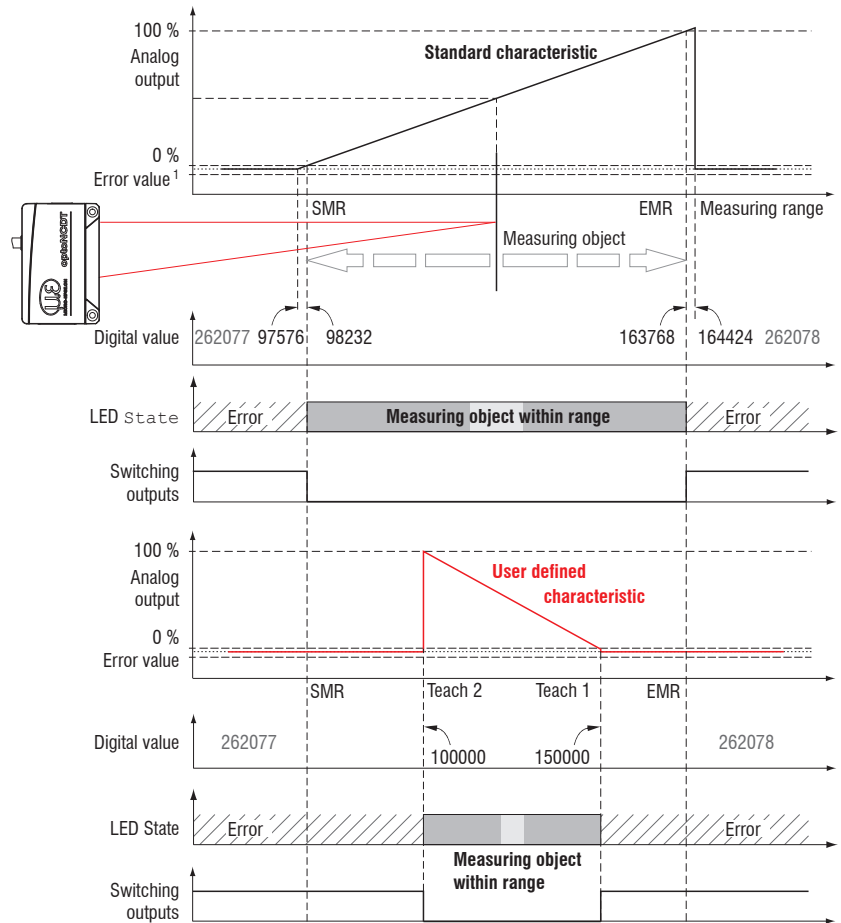

1) With current output 3.0 mA.

7.6.3.2 Output Scaling with the Select Button

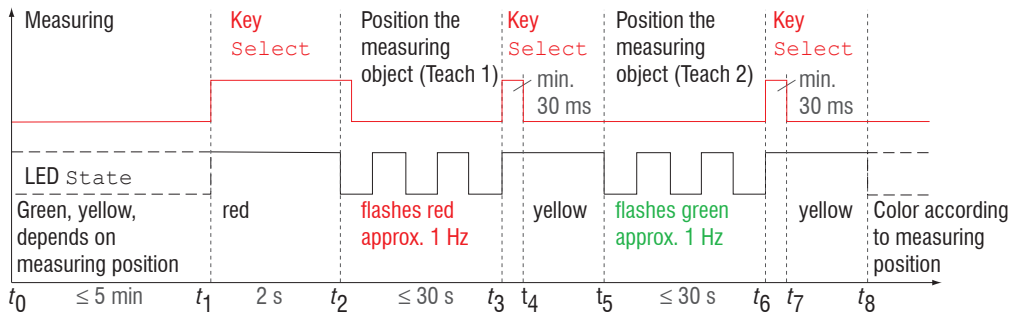

Preparation

- Deactivate key lock (menu System settings)
- Teaching process with Select button (menu Outputs)

Fig. 49 Flow chart for output scaling

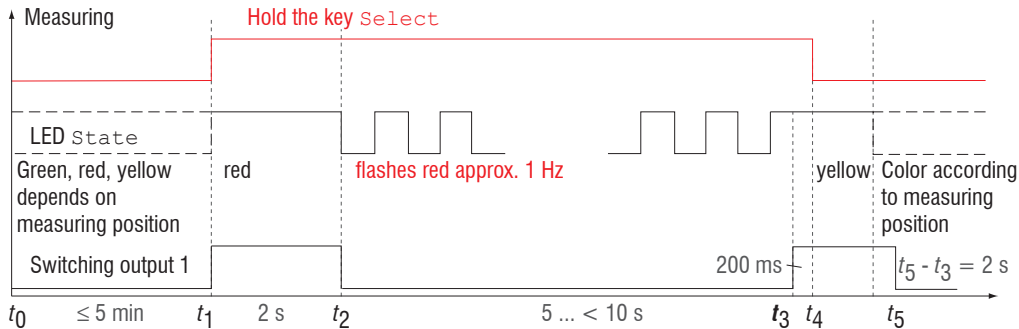
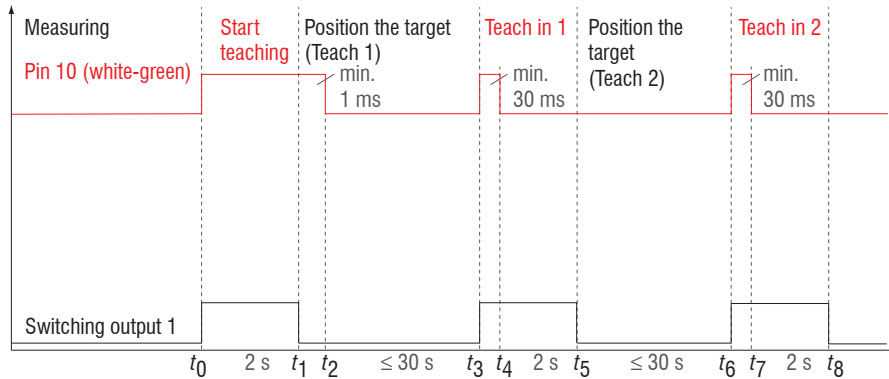

Fig. 50 Flow chart for resetting the output scaling

When the Select button is pressed longer than 10 s or not within the time frame when resetting the output scaling, the State LED will display as error. The State LED then flashes for two seconds with 8 Hz.

7.6.3.3 Output Scaling via Hardware Input

Scaling the analog output is possible via a pulse at the multi-function input, at pin 10 pigtail or the white-green wire of the sensor cable or PC1900-x.



Preparation:
Teaching process with multifunctional input (menu Outputs)

Fig. 51 Flow chart for output scaling

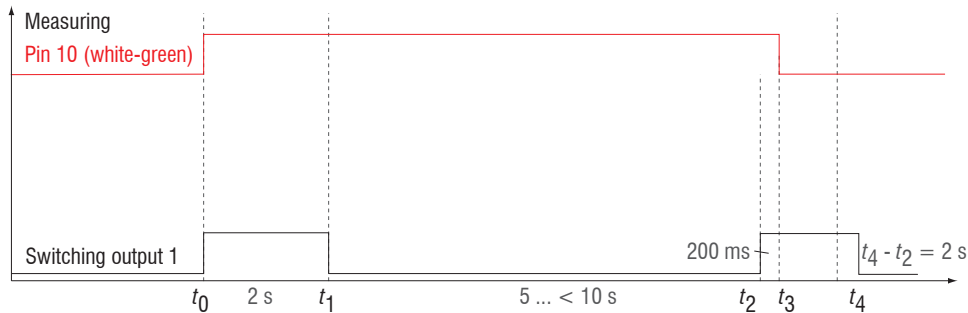

Fig. 52 Flow chart for resetting the output scaling

7.6.3.4 Calculation of the Measurement Value at the Current Output

Current output (without mastering, without teaching)

| Variables | Value range | Formula |
|----------------------------|---|-------------------------------------|
| I_{OUT} current in mA | [3.8; < 4] SMR reserve [4; 20] Measuring range [> 20; 20.2] EMR reserve | $d = \frac{(I_{OUT} - 4)}{16} * MR$ |
| MR Measuring range in mm | {10/25/50} | |
| d Distance in mm | [-0.01MR; 1.01MR] | |

Current output (with teaching)

| Variables | Value range | Formula |
|-----------------------------|---|--|
| I_{OUT} current in mA | [3.8; < 4] SMR reserve [4; 20] Measuring range [> 20; 20.2] EMR reserve | $d = \frac{(I_{OUT} - 4)}{16} * n - m $ |
| MR Measuring range in mm | {10/25/50} | |
| m, n Teaching range in mm | [0; MR] | |
| d Distance in mm | [m; n] | |

7.6.3.5 Calculation of the Measurement Value from the Voltage Output

Voltage output (without mastering, without teaching)

| Variables | Value range | Formula |
|----------------------------|--|-------------------------------|
| V_{OUT} Voltage in V | [-0.05; < 0] SMR reserve [0; 5] Measuring range [> 5; 5.05] EMR reserve | $d = \frac{V_{OUT}}{5} * MR$ |
| | [-0.1; < 0] SMR reserve [0; 10] Measuring range [> 10; 10.1] EMR reserve | $d = \frac{V_{OUT}}{10} * MR$ |
| MR Measuring range in mm | {10/25/50} | |
| d Distance in mm | [-0.01MR; 1.01MR] | |

Voltage output (with teaching)

| Variables | Value range | Formula |
|-----------------------------|--|------------------------------------|
| V_{OUT} Voltage in V | [-0.05; < 0] SMR reserve [0; 5] Measuring range [> 5; 5.05] EMR reserve | $d = \frac{V_{OUT}}{5} * n - m $ |
| | [-0.1; < 0] SMR reserve [0; 10] Measuring range [> 10; 10.1] EMR reserve | $d = \frac{V_{OUT}}{10} * n - m $ |
| MR Measuring range in mm | {10/25/50} | |
| m, n Teaching range in mm | [0; MR] | |
| d Distance in mm | [m ; n] | |

7.6.4 Switching Outputs

The two switching outputs can be used independently of each other for error or limit value monitoring of the output value Distance 1.

If the settings are done, enable the switching outputs, see [Chap. 7.6.5](#).

| | |
|-------------------------------|--|
| Full-scale error | Target outside the measuring range, target is absent or inappropriate target (too dark, metallic polished, insufficient reflection). |
| Distance outside analog range | If the distance is outside the scaled range, the switching output is activated. |
| Distance out of limit | If the value exceeds or falls below a defined limit, the switching outputs are activated. If limit value monitoring is chosen with both switching outputs, warning and alarm thresholds can be realized. |

The switching outputs are activated depending on the set switching behavior.

EMR = End of measuring range
 HV = Hysteresis value
 SMR = Start of measuring range

Max = Maximum
 Min = Minimum

Example

- Switching output 1: Distance out of limit, both
- Switching output 2: Full-scale error

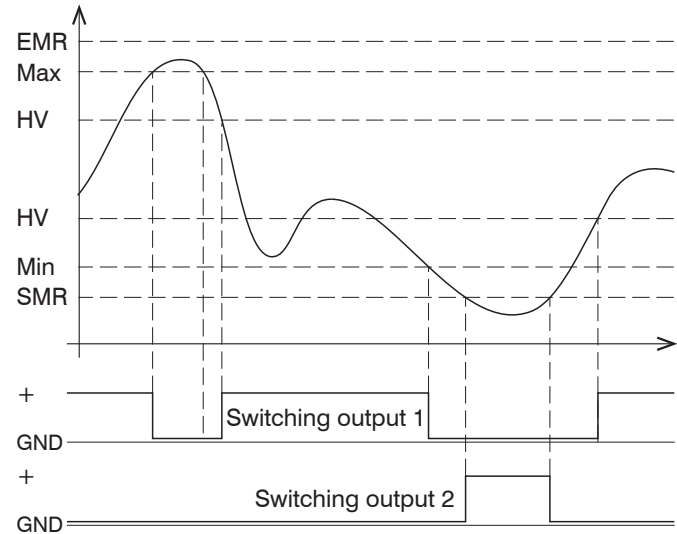

Fig. 53 Switching output 1 with limit values (NPN), Switching output 2 with full-scale error (PNP)

When exceeding the upper limit value (max), the assigned switching output 1 with NPN switching level is activated (conductive) and is then deactivated again when the next hysteresis value is not reached. The same applies when the lower limit value (minimum) is not reached. Switching output 2 reacts to a measuring range violation, see [Fig. 53](#).

| | Full-scale error | Distance outside the analog range | Distance is out of limit |
|-------------------|------------------|-----------------------------------|--------------------------|
| Minimum hold time | Yes | Yes | Yes |
| Hysteresis | No | No | Yes |

Fig. 54 Use of the parameters minimum hold time and hysteresis with the individual monitoring functions

The function of the switching outputs is generally independent of the analog output.

When active, the respective transistor of a switching output is conductive. The switching outputs are short circuit proof.

Resetting the short circuit protection:

- Eliminate the external short circuit,
- Switch the sensor off and on again or
- send software command `Reset` to the sensor.

7.6.5 Data Output

Measurement data output via individual channels can be activated/deactivated in this menu. Please refer to RS422 and Analog output, see [Chap. 7.6.2](#), see [Chap. 7.6.3](#), for the interface settings.

7.7 System Settings

7.7.1 General

When programming has been completed, store all settings permanently in a set of parameters to ensure that these settings are available when the sensor is switched on the next time.

7.7.2 Unit, Language

The web interface promotes the units millimeter (mm) and inch when displaying measuring results. You can choose German or English in the web interface. You can change the language in the menu bar.

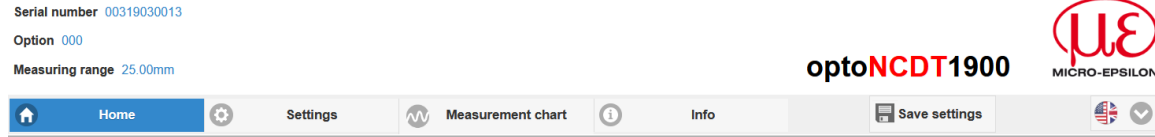

Fig. 55 Language selection in the menu bar

7.7.3 Key Lock

The key lock function for the `Function` and `Select` keys, see [Chap. 5.3](#), avoids unauthorized or unintended button operation. The key lock can only be deactivated in the `Expert` level.

| Key lock | Automatic | Countdown 1 ... 60 [min] | Value | <i>The key lock starts after expiry of the defined time. Clicking the button Refresh extends the interval until key lock starts.</i> |
|----------|-----------|--------------------------|-------|--|
| | Active | | | <i>The keys do not respond in any user level</i> |
| | Inactive | | | <i>The keys are active in any user level</i> |

Grey shaded fields require a selection.

Value Fields with dark border require entry of a value.

7.7.4 Load and Save

All settings on the sensor can be permanently saved in user programs, so-called setups, in the sensor.

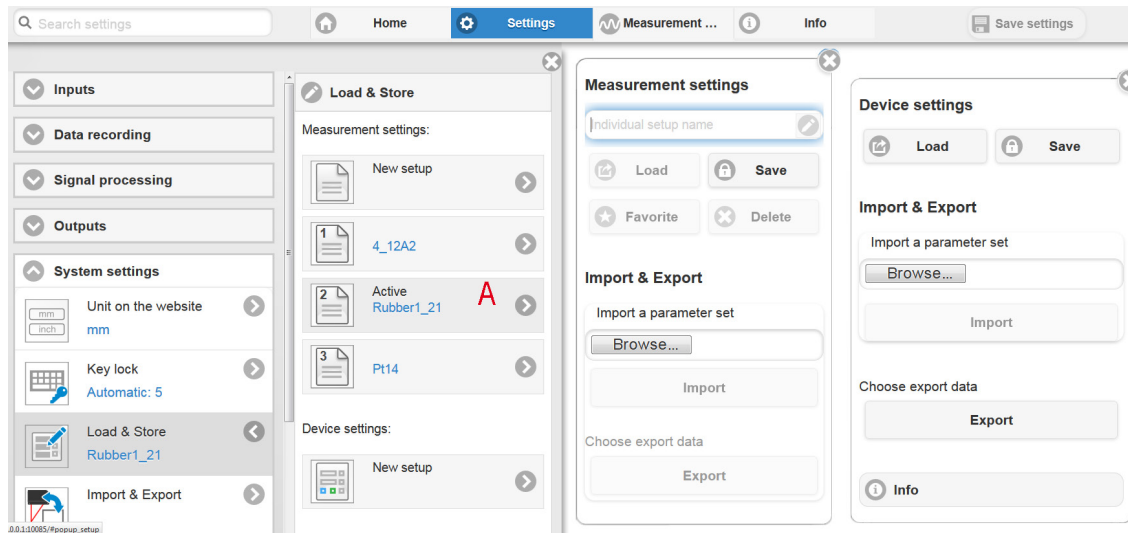
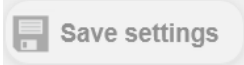

Fig. 56 Administration of user settings

| Mange setups in the sensor, possibilities and procedure | | | |
|--|--|--|--|
| Store the Settings | Activate existing setup | Save changes in active setup | Define setup after booting |
| Menu New setup | Menu Load & Save | Menu bar | Menu Load & Save |
| <p>➡ Enter the name for the</p> <p><input type="text" value="Individual setup name"/></p> <p>setup into the field e.g. Rubber1_21 and click the button Save.</p> | <p>➡ Click on the desired setup with the left mouse button, area A.</p> <p>The dialog Measurement settings opens.</p> <p>➡ Click on the button Load.</p> | <p>➡ Click on the button</p> <p></p> | <p>➡ Click on the desired setup with the left mouse button, area A.</p> <p>The dialog Measurement settings opens.</p> <p>➡ Click on the button Favorite.</p> |

| Exchange setups with PC/notebook, possibilities | |
|--|--|
| Safe setup on PC | Load setup from PC |
| Menu Load & Save | Menu Load & Save |
| <p>➤ Click on the desired setup with the left mouse button, area A.</p> <p>The dialog <code>measurement settings</code> opens.</p> <p>➤ Click on the button <code>Export</code>.</p> | <p>➤ Click on <code>New setup</code> with the left mouse button.</p> <p>The dialog <code>measurement settings</code> opens.</p> <p>➤ Click on the button <code>Search</code>.</p> <p>A Windows dialog for file selections opens.</p> <p>➤ Choose the desired file and click on the button <code>Open</code>.</p> <p>➤ Click on the button <code>Import</code>.</p> |

7.7.5 Import, Export

A parameter set includes the current settings, setup(s) and the initial setup when booting the sensor. The `Import` & `Export` menu enables easy exchange of parameter sets with a PC/notebook.

| Exchange of parameter sets with PC/notebook, possibilities | |
|---|--|
| Storing parameter set on PC | Loading parameter set from PC |
| Menu <code>Import & Export</code> | Menu <code>Import & Export</code> |
| <p>➡ Click on the button <code>Parameter set</code> with the left mouse button.</p> <p>The dialog <code>Choose export data</code> opens.</p> <p>➡ Compose a parameter set by selecting/deselecting the checkboxes.</p> <p>➡ Click on the button <code>Transmit parameter set</code>.</p> <p>A Windows dialog for data transfer opens.</p> <p>➡ Acknowledge the dialog with <code>OK</code>.</p> <p>The operating system files the parameter set in <code>Download</code>. The file name for the adjacent example is <code><... \Downloads\ILD1750_BA-SICSETTINGS_MEASSETTINGS_...</code></p> | <p>➡ Click on the button <code>Search</code>.</p> <p>A Windows dialog for file selections opens.</p> <p>➡ Choose the desired file and click on the button <code>Open</code>.</p> <p>The dialog <code>Choose import data</code> opens.</p> <p>➡ Determine the operations to be performed by selecting/deselecting the checkboxes.</p> <p>➡ Click on the button <code>Transmit parameter set</code>.</p> |

✕

Choose export data

Settings

`4_12A2`

`Rubber1_21`

`Pt14`

Initial Setup at booting

`Rubber1_21`

General Sensor settings

`General Sensor settings`

Transmit file

In order to avoid that an already existing setup is overwritten unintentionally during import, an automatic security request is carried out (see adjacent figure).

Options during import

Overwrite existing setups (with the same name)

Apply settings of the imported initial setup

7.7.6 Access Authorization

Assigning passwords prevents unauthorized changes to sensor settings. Password protection is not enabled as a factory setting. The sensor works on the Professional level. After the sensor has been configured, you should enable password protection. The standard password for the Professional level is “000”.

i A software update will not change the standard password or a custom password. The Professional level password is setup-independent, and is not loaded or stored during setup.

User can do the following:

| | User | Professional |
|--|------|--------------|
| Password required | no | yes |
| Read inputs, signal processing, outputs, system settings | yes | yes |
| Change inputs, signal processing, outputs, system settings | no | yes |
| Change password | no | yes |
| Toggling between measurement chart and video signal | no | yes |
| Scale graphs | yes | yes |
| Restore factory settings | no | yes |

Fig. 57 Permissions within the user hierarchy

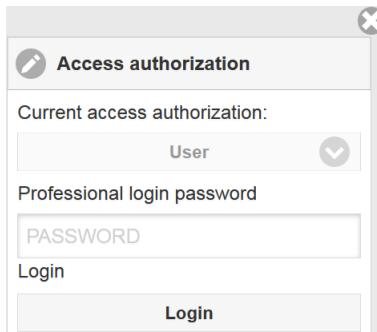

Enter the standard password “000” or a custom password into the Password box, and click Login to confirm.

Change to the `User` level by clicking the `Logout` button.

Fig. 58 Changing to professional level

The user management enables to define a user-specific password in Expert mode.

| | | |
|----------------------------|----------------------------|--|
| Password | <i>Value</i> | <i>All passwords are case-sensitive. Numbers are allowed, but special characters are not permitted. The maximum length is 31 characters.</i> |
| User level when restarting | <i>User / Professional</i> | <i>Defines the user level that is enabled when the sensor starts the next time. Micro-Epsilon recommend to select User level.</i> |

After the sensor has been configured, you should enable password protection. Please write down the password for later use.

7.7.7 Reset Sensor

| | | | |
|--------------|-----------------------------|---------------|---|
| Reset sensor | <i>Measurement settings</i> | <i>Button</i> | <i>The settings for measuring rate, trigger, evaluation range, selection of peak, error handling, averaging, Zeroing/Mastering, reduction of data and setups are deleted. The 1st preset is loaded.</i> |
| | <i>Device settings</i> | <i>Button</i> | <i>The settings baud rate, language, unit, key lock and echo mode are deleted and the default parameters are loaded.</i> |
| | <i>Reset all</i> | <i>Button</i> | <i>By clicking the button the settings for the sensor, measurement settings, access permission, password and setups are deleted. The 1st preset is loaded.</i> |
| | <i>Reboot sensor</i> | <i>Button</i> | <i>By clicking the button the sensor is rebooted with the settings made in the favorite setup, see Chap. 7.7.4.</i> |

 Grey shaded fields require a selection.

 *Value* Fields with dark border require entry of a value.

8. Digital Interfaces RS422

8.1 Preliminary Remarks

The interface RS422 has a maximum baud rate of 4 MBaud. The factory-set baud rate is 921.6 kBaud.

Data format: Measurement values in binary format, commands as an ASCII string.

Interface parameter: 8 Data bits, no parity, one stop bit (8N1).

I Disconnect or connect the D-sub connection between RS422 and USB converter when the sensor is disconnected from power supply only.

8.2 Measurement Data Format

18 bits are transmitted per output value, see [Chap. 7.6.2](#). An output value is divided into three bytes that differ in the two most significant bits. The transmission of additional output values is optional.

Output value 1 / additional:

| | | | | | | | | |
|--------|---|----------------|-----|-----|-----|-----|-----|-----|
| L-Byte | 0 | 0 | D5 | D4 | D3 | D2 | D1 | D0 |
| M-Byte | 0 | 1 | D11 | D10 | D9 | D8 | D7 | D6 |
| H-Byte | 1 | 0 ¹ | D17 | D16 | D15 | D14 | D13 | D12 |

Output sequence: L-Byte, M-Byte, H-Byte.

1) Bit 7 in the H byte is set to 0 for the last output value. This simultaneously represents the identifier of a new block. With all previous output values in the same block, the 7th is in the H byte 1. Depending on the measuring rate, baud rate and output data rate output all data can be output in one block. If data output is overloaded, an error value is transmitted within the distance value. Use the command GETOUTINFO_RS422 to query for data selection and output sequence.

8.3 Conversion of the Binary Data Format

For conversion purposes the H-Byte, M-Byte and L-Byte must be identified on the basis of the two first bits (flag bits), the flag bits deleted and the remaining bits compiled into a 18 bit data word.

Result of conversion:

| | | | | | | | | | | | | | | | | | |
|-----|-----|-----|-----|-----|-----|-----|-----|----|----|----|----|----|----|----|----|----|----|
| D17 | D16 | D15 | D14 | D13 | D12 | D11 | D10 | D9 | D8 | D7 | D6 | D5 | D4 | D3 | D2 | D1 | D0 |
|-----|-----|-----|-----|-----|-----|-----|-----|----|----|----|----|----|----|----|----|----|----|

Conversion must be done in the application program.

i The sensor continues to deliver measurement values to the RS422 output even while communicating with the sensor.

For the data transmission with a PC the Micro-Epsilon IF2008/PCIE PCI BUS interface card is suitable. This can be connected to the sensor via the PC1900-x/IF2008 interface cable, which is also available as an option. The IF2008/PCIE combines the three bytes for the data word and saves them in the FIFO. The 18 bits are used for measurement values and error values. As standard, the IF2008 interface card is suitable for connecting two or (via a Y intermediate cable available as an option) up to four sensors plus two additional incremental encoders. For further information, please refer to the descriptions of the IF2008/PCIE interface card and associated MEDAQLib driver program.

You will find the latest program routine at: www.micro-epsilon.com/link/software/medaqlib.

9. Cleaning

Cleaning of the protective screens is recommended periodically.

Dry Cleaning

Therefore an optics anti-static brush is suitable or bleeding the screen with dehumidified, clean and oil-free compressed air.

Wet Cleaning

For cleaning the protective screen use a clean, soft, lint-free cloth or lens cleaning paper with pure alcohol (isopropyl).

Never use standard glass cleaner or other cleaning agents.

10. Software Support with MEDAQLib

MEDAQLib offers you a documented driver DLL. Therewith you embed optoNCDT laser sensors, in combination with

- the 1-way converter IF2001/USB or
- the 4-way converter IF2004/USB and connection cable PC1900-x/IF2008 (IF2008-Y) or
- the PCI interface card IF 2008/PCIE and connection cable PC1900-x/IF2008 and IF2008-Y-adapter cable

into an existing or a customized PC software.

MEDAQLib

- contains a DLL, which can be imported into C, C++, VB, Delphi and many additional programs,
- makes data conversion for you,
- works independent of the used interface type,
- features by identical functions for the communication (commands),
- provides a consistent transmission format for all Micro-Epsilon sensors.

For C/C++ programmers MEDAQLib contains an additional header file and a library file. You will find the latest driver / program routine at:

www.micro-epsilon.com/service/download/
www.micro-epsilon.de/link/software/medaqlib/

11. Disclaimer

All components of the device have been checked and tested for functionality in the factory. However, should any defects occur despite careful quality control, these shall be reported immediately to Micro-Epsilon or to your distributor / retailer.

Micro-Epsilon undertakes no liability whatsoever for damage, loss or costs caused by or related in any way to the product, in particular consequential damage,

e.g., due to

- non-observance of these instructions/this manual,
- improper use or improper handling (in particular due to improper installation, commissioning, operation and maintenance) of the product,
- repairs or modifications by third parties,
- the use of force or other handling by unqualified persons.

This limitation of liability also applies to defects resulting from normal wear and tear (e.g., to wearing parts) and in the event of non-compliance with the specified maintenance intervals (if applicable).

Micro-Epsilon is exclusively responsible for repairs. It is not permitted to make unauthorized structural and / or technical modifications or alterations to the product. In the interest of further development, Micro-Epsilon reserves the right to modify the design.

In addition, the General Terms of Business of Micro-Epsilon shall apply, which can be accessed under Legal details | Micro-Epsilon <https://www.micro-epsilon.com/legal-details/>.

For translations into other languages, the German version shall prevail.

12. Service, Repair

If the sensor or sensor cable is defective:

- If possible, save the current sensor settings in a parameter, see [Chap. 7.7.4](#), set to reload them into the sensor after the repair.
- Please send us the affected parts for repair or exchange.

If the cause of a fault cannot be clearly identified, please send the entire measuring system to:

MICRO-EPSILON Optronic GmbH
Lessingstraße 14
01465 Langebrueck / Germany

Tel. +49 (0) 35201 / 729-0
Fax +49 (0) 35201 / 729-90
optronic@micro-epsilon.com
www.micro-epsilon.com

13. Decommissioning, Disposal

In order to avoid the release of environmentally harmful substances and to ensure the reuse of valuable raw materials, we draw your attention to the following regulations and obligations:

- Remove all cables from the sensor and/or controller.
- Dispose of the sensor and/or the controller, its components and accessories, as well as the packaging materials in compliance with the applicable country-specific waste treatment and disposal regulations of the region of use.
- You are obliged to comply with all relevant national laws and regulations.

For Germany / the EU, the following (disposal) instructions apply in particular:





- Waste equipment marked with a crossed garbage can must not be disposed of with normal industrial waste (e.g. residual waste can or the yellow recycling bin) and must be disposed of separately. This avoids hazards to the environment due to incorrect disposal and ensures proper recycling of the old appliances.





- A list of national laws and contacts in the EU member states can be found at https://ec.europa.eu/environment/topics/waste-and-recycling/waste-electrical-and-electronic-equipment-weee_en. Here you can inform yourself about the respective national collection and return points.
- Old devices can also be returned for disposal to Micro-Epsilon at the address given in the imprint at <https://www.micro-epsilon.com/legal-details/>.
- We would like to point out that you are responsible for deleting the measurement-specific and personal data on the old devices to be disposed of.
- Under the registration number WEEE-Reg.-Nr. DE28605721, we are registered at the foundation Elektro-Altgeräte Register, Nordost-park 72, 90411 Nuremberg, as a manufacturer of electrical and/or electronic equipment.

Appendix

A 1 Optional Accessories

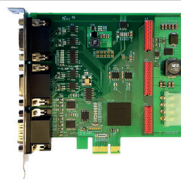
| | | |
|------------------------------|---|--|
| IF2001/USB |  | <p>Converter RS422 to USB, type IF2001/USB, useable for cable PC1900-x/OE, inclusive driver, connections: 1 × female connector 10-pin (cable clamp) type Würth 691361100010, 1x female connector 6-pin (cable clamp) type Würth 691361100006</p> |
| IF2004/USB |  | <p>4 channel converter RS422 to USB useable for cable PC1900-x/IF2008 (IF2008-Y), inclusive driver, connections: 2 × Sub-D, 1 × terminal block</p> |
| C-Box/2A |  | <p>Computation of two digital input signals, useable for cable PC1900-x/C-Box. D/A conversion of a digital measurements, output through current and voltage output.</p> |
| IF2030/PNET IF2030/ENETIP |  | <p>Interface module for PROFINET or Ethernet connection of a Micro-Epsilon sensor with RS485 or RS422 interface, suitable for PC1900-x/OE cables, top-hat rail housing, incl. GSDML file for software integration in the PLC</p> |

| | | |
|------------------------|---|--|
| PS2020 |  | <p>Power supply for mounting on DIN rail, input 230 VAC, output 24 VDC/2.5 A LPS and NEC Class 2 compliant</p> |
| IF2008/PCIE |  | <p>The IF2008/PCIE interface card enables the synchronous capture of 4 digital sensor signals series optoNCDT 1750 or others or 2 encoders. In combination with IF2008E a total of 6 digital signals, 2 encoder, 2 analog signals and 8 I/O signals can be acquired synchronously.</p> |
| IF2008-Y adapter cable |  | <p>Used to connect two sensors with interface cable PC2300-x/IF2008 to a port of the IF2008/PCIE.</p> |
| PC1900-x/OE | | <p>Supply and output cable, Length $x = 3, 6, 9$ or 15 m 17-pin molded connector resp. open ends</p> |
| PC1900-x/IF2008 | | <p>Interface and supply cable Length $x = 3, 6, 9$ or 15 m 17-pin. molded connector resp. 15-pin Sub-D-connector</p> |
| PC1900-x | | <p>Supply and output cable, Length $x = 3, 6, 9$ or 15 m</p> |

PC1900-x/C-Box



M12 threaded socket

15-pin. Sub-D plug for connection to C-Box

Supply and output cable
Length $x = 3, 6, 9$ or 15 m
15-pin Sub-D connector

A 2 Factory Setting

| | |
|----------------|-------------------------------|
| Averaging | Median with 9 values |
| Peak selection | Highest peak |
| Output | Analog and switching output 1 |

| | |
|--------------|-------------|
| RS422 | 921.6 kBaud |
| Trigger mode | No trigger |
| Language | German |

| | |
|----------------|-------|
| Password | „000“ |
| Measuring rate | 4 kHz |

| | |
|-----------------|---|
| Measuring range | 100 % FSO: I = 20 mA , digital 163768 0 % FSO: I = 4 mA, digital 98232 |
|-----------------|---|

| | |
|----------------|------------------------------|
| Error handling | Error output, no measurement |
|----------------|------------------------------|

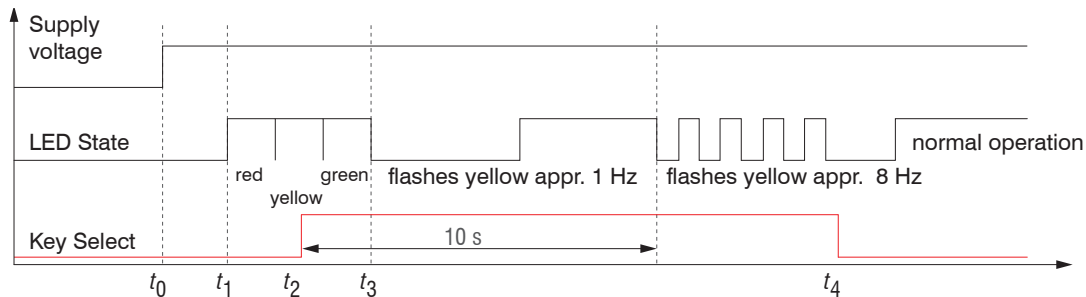

Fig. 60 Flow chart to start a sensor with factory setting

- t_0 : power supply is on
 - $t_1 \dots t_3$: both LEDs signalize the start sequence (red-yellow-green for 1 sec. each)
 - t_2 : Key Select is pressed during start sequence ($t_1 \dots t_3$)
 - t_4 : Key Select is released while the LED State is flashing red
- $\Delta t = t_4 - t_2$; Δt (key press period) must be at least 10 sec., max. 15 sec.

Reset to factory setting: Press the Select key after having switched on the sensor while the two LEDs light up „red - yellow - green“. Hold the key pressed. After 10 seconds, the Status LED starts flashing quickly. If you release the key while it flashes quickly, the sensor is reset to factory settings. If you hold the key pressed for longer than 15 seconds, the sensor is not reset to factory settings.

If the Select key is kept pressed when switching on the sensor (or with a reset), the sensor switches to the Bootloader mode.

A 3 ASCII Communication with Sensor

A 3.1 General

The ASCII commands can be sent to the sensor via the RS422 interface. All commands, inputs and error messages are effected in English.

One command always consists of a command name and zero or several parameters, which are separated by blanks and are completed with LF. If blanks are used in parameters, the parameter must be set in quotation marks.

Example: Switch on the output via RS422

OUTPUT RS422 ←↵

Advice: ←↵ must include LF, but may also be CR LF.

Declaration: LF Line feed (line feed, hex 0A)

CR Carriage return (carriage return, hex 0D)

←↵ Enter (depending on the system hex 0A or hex 0D0A)

The currently set parameter value is returned, if a command is activated without parameters.

The input formats are:

```
<Command name> <Parameter1> [<Parameter2> [...]]
```

```
<Command name> <Parameter1> <Parameter2> ... <Parameter...>
```

or a combination thereof.

Parameters in []-brackets are optional and require the input of the parameter standing in front. Sequent parameters without []-brackets are to input compulsory, that is, it must not be omitted a parameter.

Alternative inputs of parameter values are displayed separately by „|“, for example the values „a“, „b“ or „c“ can be set for “a|b|c”.

Parameter values in <> brackets are selectable from a value range.

Declarations on format:

| | |
|-----------------|---|
| „a b“ | Value of the parameter can be set to the value “a” or “b”. |
| „ P1 P2“ | It requires that both parameters “P1” and “P2” are set. |
| „ P1 [P2 [P3]]“ | The parameters “P1”, “P2” and “P3” can be set, whereby “P2” may only be set, if “P1” is set and “P3” only if “P1” and “P2” are set. |
| „<a>“ | The value of the parameter lies in a value range of “... to ...”, see parameter description. |

Parameter values without peak brackets can only assume discrete values, see parameter description.

Parantheses are to be understood as a grouping, that is, for a better articulation „P1 P2 | P3“ is written as „(P1 P2) | P3“.

Example without []:

„PASSWD <Old password> <New password> <New password>“

- To change the password, all three parameters are to be input.

The output format is:

<Command name> <Parameter1> [<Parameter2> [...]]

The reply can be used again as command for the parameter setting without changes. Optional parameters are only returned, if the returning is necessary. For example, the activated output values are returned by command Data selection additional values. After processing a command always a return and a prompt (“->”) is returned. In the case of an error an error message is before the prompt, that begins with „Exxx“, where xxx is a unique error number. Also warnings („Wxxx“) can be output instead of error messages.

These are analogous to the error messages. In case of warnings the command is executed.

The replies to the commands GETINFO and PRINT are useful for support requests to the sensor, because they contain sensor settings.

A 3.2 Overview Commands

| Group | Chapter | Command | Short description |
|------------|---------------------------------|----------------|--|
| General | | | |
| | Chap. A 3.2.1.1 | HELP | Help on commands |
| | Chap. A 3.2.1.2 | GETINFO | Request sensor information |
| | Chap. A 3.2.1.3 | LANGUAGE | Determine language of the web interface |
| | Chap. A 3.2.1.4 | RESET | Reboot sensor |
| | Chap. A 3.2.1.5 | RESETCNT | Reset counter |
| | Chap. A 3.2.1.6 | ECHO | Switching the command reply, ASCII interface |
| | Chap. A 3.2.1.7 | PRINT | Output of all sensor settings |
| | Chap. A 3.2.1.8 | SYNC | Synchronization |
| | Chap. A 3.2.1.9 | TERMINATION | Terminating resistor |
| User Level | | | |
| | Chap. A 3.2.2.1 | LOGIN | Change of user level |
| | Chap. A 3.2.2.2 | LOGOUT | Change to user in the user level |
| | Chap. A 3.2.2.3 | GETUSERLEVEL | User level request |
| | Chap. A 3.2.2.4 | STDUSER | Setting the standard user |
| | Chap. A 3.2.2.5 | PASSWD | Change password |
| Triggering | | | |
| | Chap. A 3.2.3.1 | TRIGGERLEVEL | Active level triggering |
| | Chap. A 3.2.3.2 | TRIGGERMODE | Trigger Type |
| | Chap. A 3.2.3.3 | TRIGGERSOURCE, | Select Trigger Source |
| | Chap. A 3.2.3.4 | TRIGGERAT | Effect of the Trigger Input |
| | Chap. A 3.2.3.5 | MFILEVEL | Select level for switching input |
| | Chap. A 3.2.3.6 | TRIGGERCOUNT | Number of measurement values displayed |
| | Chap. A 3.2.3.7 | TRIGGERSW | Software - Trigger Pulse |

| Interfaces | | | |
|--------------------|---------------------------------|------------------------|--|
| | Chap. A 3.2.4.1 | BAUDRATE | Setting transmission rate of RS422 |
| | Chap. A 3.2.4.2 | ERROROUT1/2 | Activating switching outputs |
| | Chap. A 3.2.4.3 | ERRORLEVELOUT1/2 | Output level switching outputs |
| | Chap. A 3.2.4.4 | ERRORLIMITCOMPARETO1/2 | Monitoring function switching outputs |
| | Chap. A 3.2.4.5 | ERRORLIMITVALUES1/2 | Threshold switching output |
| | Chap. A 3.2.4.6 | ERRORHYSTERESIS | Hysteresis value switching outputs |
| | Chap. A 3.2.4.7 | ERROROUTHOLD | Min. switching time of active switching output |
| Handling of setups | | | |
| | Chap. A 3.2.5.1 | IMPORT | Load parameters |
| | Chap. A 3.2.5.2 | EXPORT | Export sensor settings |
| | Chap. A 3.2.5.3 | MEASSETTINGS | Load/save measurement settings |
| | Chap. A 3.2.5.4 | BASICSETTINGS | Load/save device settings |
| | Chap. A 3.2.5.5 | SETDEFAULT | Factory settings |
| Analog output | | | |
| | Chap. A 3.2.6.1 | ANALOGRANGE | Voltage or current output |
| | Chap. A 3.2.6.2 | ANALOGSCALEMODE | Scaling analog output |
| | Chap. A 3.2.6.3 | ANALOGSCALERANGE | Scaling limits analog output |
| | Chap. A 3.2.6.4 | ANALOGSCALESOURCE | Port for teach function |
| Key function | | | |
| | Chap. A 3.2.7.1 | KEYLOCK | Set key lock |

| Measurement | | | |
|-------------|----------------------------------|------------------|--|
| | Chap. A 3.2.8.1 | TARGETMODE | Choice of material-dependent measurement algorithm |
| | Chap. A 3.2.8.2 | MEASPEAK | Peak selection, diffuse sensor arrangement |
| | Chap. A 3.2.8.3 | MEASRATE | Select a Measuring Rate |
| | Chap. A 3.2.8.4 | SHUTTER | Exposure time |
| | Chap. A 3.2.8.5 | SHUTTERMODE | Automatic or manual exposure time |
| | Chap. A 3.2.8.6 | EXPOSUREMODE | Behavior for automatic exposure time regulation |
| | Chap. A 3.2.8.7 | LASERPOW | Selection of laser power |
| | Chap. A 3.2.8.8 | ROI | Masking the Evaluation Range |
| | Chap. A 3.2.8.9 | COMP | Selection of measurement averaging |
| | Chap. A 3.2.8.10 | META_MASTER | Possible signals for mastering |
| | Chap. A 3.2.8.11 | MASTER | Start/stop mastering or zeroing |
| | Chap. A 3.2.8.12 | MASTERSIGNAL | Master value |
| | Chap. A 3.2.8.13 | MASTERSOURCE | Choose port for mastering |
| Data output | | | |
| | General | | |
| | Chap. A 3.2.9.1 | OUTPUT | Selection measurement value output |
| | Chap. A 3.2.9.2 | OUTREDUCEDEVICE | Selection measurement value output for reduction |
| | Chap. A 3.2.9.3 | OUTREDUCECOUNT | Reduction of measurement value output |
| | Chap. A 3.2.9.4 | OUTHOLD | Setting of error processing |
| | Chap. A 3.2.9.5 | GETOUTINFO_RS422 | List intended data for RS422 |
| | Chap. A 3.2.9.6 | META_OUT_RS422 | Possible data for RS422 |
| | Chap. A 3.2.9.7 | OUT_RS422 | Measurement data output with RS422 |

A 3.2.1 General Commands

A 3.2.1.1 HELP

Issues a help for every command.

Command without parameter

```
<Command> // Command is executed.
```

Command with parameter.

```
<Command>
```

```
// Show current parameter value
```

```
<Command> <Parameter1> [<Parameter2> [...]]
```

```
// Set parameters, number of parameters varies
```

```
<Command> <Parameter1> <Parameter2> ... <Parameter...>
```

```
// Set parameters, number of parameters is fixed
```

Response to a command

-> Cursor, the sensor waits for an entry

E<dd> <Msg> Error message, execution refused

W<dd> <Msg> Warning

<ddd> Three digits

<Msg> Message

Format

() Group

[] Optional parameters

<> Placeholder

| Alternative

If spaces are used in parameters, the parameters must be placed in quotation marks.

Examples:

```

a|b           // Use a or b
a b          // Both parameters are required
a [b [c]]    // Indefinite number of parameters: a, a b, or a b c
PASSWORD <Old password>
<New password> <New password> // In order to change the password, all parameters are required.

```

Welche Unterkommandos gibt es zu dem Befehl MEASSETTINGS?

➡ Senden Sie den Befehl HELP MEASSETTINGS an den Sensor

->help meassettings

MEASSETTINGS <subcommand> [<name>]

Handle application-dependent measuring settings. Either use a PRESET prepared by the manufacturer (PRESETMODE and setting from PRESETLIST), or use a user-defined setting.

Each setup can be stored as user-defined setting.

```

PRESETMODE:           Get current preset mode
PRESETMODE <mode>:    Set preset mode, <mode> = STATIC|BALANCED|DYNAMIC
PRESETLIST:           List all manufacturer settings
CURRENT:              Get name of current setting
READ <name>:          Load setting <name> from persistent memory
STORE <name new>:     Write user-defined setting into persistent memory
RENAME <name> <name new> [FORCE]: Rename user-defined setting
DELETE <name>:        Remove user-defined setting <name> from persistent
                        memory
INITIAL AUTO:         Load the last stored setting when the sensor is started
LIST:                 List the names of all stored user-defined settings
FORCE:                Allow overwriting of an existing user-defined setting.
<name>                The name of a manufacturer setting or a user-defined
                        setting.
<name new>            The name of a user-defined setting. Names must contain
                        at least 2 characters, and can contain a maximum of 31 characters. The
                        following characters are permitted: a-zA-Z0-9_ The names of presets are
                        not allowed, and names may not begin with ``AUTO``.

```

A 3.2.1.2 GETINFO, Sensor Information

```
GETINFO
```

Controller data are queried. Output as per example below:

```
->GETINFO
Name:          ILD1900-25           //Model name sensor, sensor series
Serial:        00320030017         // Serial number
Option:        001                  //Option number of sensor
Article:       4120265.001         // Article number of sensor
Cable head:    Pigtail
Measuring range: 25.00mm           // Measuring range of the sensor
Version:       001.002.001         //Software version
Hardware-rev:  00
Boot version:  001.000
->
```

A 3.2.1.3 LANGUAGE Web Interface

```
LANGUAGE DE | EN
```

Determines the language for the web interface

- DE: set language to German
- EN: set language to English

The web interface is displayed in the selected language.

A 3.2.1.4 RESET, Boot Sensor

RESET

The sensor is restarted.

A 3.2.1.5 RESETCNT, Reset Counter

RESETCNT [TIMESTAMP] [MEASCNT] [TRIGGEREVENT] [TRIGGERVALUE]

Reset the internal counters, e.g. to synchronize.

- TIMESTAMP: resets the time stamp
- MEASCNT: resets the measured value counter
- TRIGGEREVENT: resets the trigger event counter
- TRIGGERVALUE: resets the trigger value counter

A 3.2.1.6 ECHO, Switching the Command Reply, ASCII Interface

ECHO ON|OFF

Setting the command reply with an ASCII command:

- ON: command reply on, for example ok (or error message) ->
- OFF: command reply off, e.g. ->

A 3.2.1.7 PRINT, Sensor Settings

PRINT

Print serves the output of all sensor settings

Example response:

```

GETUSERLEVEL PROFESSIONAL
STDUSER PROFESSIONAL
UNIT MM
LANGUAGE DE
KEYLOCK AUTO 5 (IS_ACTIVE)
BAUDRATE 921600
SYNC NONE
TERMINATION OFF
MFILEVEL HTL
LASERPOW FULL
MEASRATE 1.000
TARGETMODE STANDARD
MEASPEAK DIST1
COMP MEDIAN 9
TRIGGERSOURCE NONE
TRIGGERMODE EDGE
TRIGGERLEVEL HIGH
TRIGGERAT INPUT
TRIGGERCOUNT 1
MASTERSIGNAL
MASTERSIGNAL DIST1 0.000
MASTERSOURCE NONE

```

```

OUTPUT RS422
OUTHOLD NONE
OUTREDUCEDEVICE RS422
OUTREDUCECOUNT 1000
OUT_RS422 DIST1 COUNTER
ANALOGRANGE 0-10V
ANALOGSCALEMODE STANDARD
ANALOGSCALERANGE 0.00000 10.00000
ANALOGSCALESOURCE NONE
ERROROUT1 LI1
ERROROUT2 DIST
ERRORLEVELOUT1 NPN
ERRORLEVELOUT2 NPN
ERROROUTHOLD 0
ERRORLIMITCOMPARETO1 LOWER
ERRORLIMITCOMPARETO2 LOWER
ERRORLIMITVALUES1 0.0000 10.0000
ERRORLIMITVALUES2 0.0000 10.0000
ERRORHYSTERESIS 0.0000
SHUTTERMODE MEAS
SHUTTER 100.0
->

```

A 3.2.1.8 SYNC

SYNC NONE | MASTER | MASTER_ALT | SLAVE | SLAVE_ALT | SLAVE_MFI

Setting the type of synchronization:

- NONE: No synchronization
- MASTER: The sensor is master, i.e. it transmits synchronization pulses on the output.
- MASTER_ALT: The sensor is master, i.e. it transmits synchronization pulses with every 2nd cycle. Both sensors measure alternately, e.g. thickness measurement using 2 sensor on transparent material
- SLAVE: Sensor is slave and expects synchronization pulses from another optoNCDT 1750.
- SLAVE_ALT: Sensor is slave and expects synchronization pulses from a master sensor. Both sensors measure alternately, e.g. thickness measurement using 2 sensor on transparent material
- SLAVE_MFI: Sensor is slave and expects synchronization pulses from an external source at the multi-function input. Synchronization is performed with rising edge.

A 3.2.1.9 TERMINATION

TERMINATION OFF | ON

Activation of a terminating resistor in synchronization instruction

Switches off/on the termination resistor at the Sync/Trig synchronization input in order to avoid reflection.

OFF: no terminating resistor

ON: with terminating resistor

A 3.2.2 User Level

A 3.2.2.1 LOGIN, Change of the User Level

```
LOGIN <Password>
```

Enter the password to switch to a different user level. The following user levels exist:

- USER (standard user): “read-only” access to all elements and graphical display of output values of web interface
- PROFESSIONAL (Expert): Read/write access to all elements

A 3.2.2.2 LOGOUT, Change into User Level

```
LOGOUT
```

Sets the user level to USER.

A 3.2.2.3 GETUSERLEVEL, User Level Request

```
GETUSERLEVEL
```

Request the current user level.

A 3.2.2.4 STDUSER, Set Standard User

```
STDUSER USER|PROFESSIONAL
```

Sets the standard user, who is logged in after system start. Standard user does not change with LOGOUT, i.e. login as standard user is done automatically after the command RESET or power supply of sensor is switched on.

A 3.2.2.5 PASSWD, Change Password

```
PASSWD <Old Password> <New Password> <New Password>
```

Changes the password for the PROFESSIONAL level.

The old password must be entered once, and the new password twice. If the new passwords do not match, an error message is displayed. A password may only contain letters (A to Z) and numbers, but no letters with accents or umlauts. Upper and lower case are distinguished. The maximum length is 31 characters.

A 3.2.3 Triggering

The multi-function input also serves as trigger input

A 3.2.3.1 TRIGGERLEVEL, Active Level Triggering

TRIGGERLEVEL HIGH | LOW

- HIGH: Edge triggering: Rising edge, level triggering: High-active
- LOW: Edge triggering: Falling edge, level triggering: Low-active

A 3.2.3.2 TRIGGERMODE

TRIGGERMODE EDGE | PULSE

Defines the trigger type.

- PULSE: Level triggering
- EDGE: Edge triggering

A 3.2.3.3 TRIGGERSOURCE, Trigger Source

TRIGGERSOURCE NONE | MFI | SYNCIO | SOFTWARE

- NONE: Triggering is deactivated
- MFI: Use multi-function input for triggering.
- SYNCIO: Use synchronization ports for triggering
- SOFTWARE: Triggering is controlled by the TRIGGERSW command

A 3.2.3.4 TRIGGERAT, Effect of the Trigger Input

TRIGGERAT INPUT | OUTPUT

- INPUT: Triggering the measured value recording. When calculating the mean, measured values immediately before the trigger event are not included; instead older measurement values are used, which were output in previous trigger events.
- OUTPUT: Triggering the measurement value output. When calculating the mean, measured values immediately before the trigger event are used.

A 3.2.3.5 MFILEVEL, Input Level Multi-Function Input

MFILEVEL HTL | TTL

Selection of switching or trigger level for the multi-function input

- HTL: Input expects HTL level
- TTL: Input expects TTL level

A 3.2.3.6 TRIGGERCOUNT, Number of Output Measurement Values

TRIGGERCOUNT INFINITE | <n>

<1...16382>

Number of Output Measurement Values with Triggering

- INFINITE: Start of continuous output after the first trigger event
- <n>: Number of measured values to be output after every trigger event n = 1 ...16382.

A 3.2.3.7 TRIGGERSW, Software Trigger Pulse

TRIGGERSW SET|CLR

Generates a software trigger pulse.

- SET: Generates one single trigger pulse when edge triggering (EDGE) is active. Continuously generates trigger pulses with level triggering (PULSE)
- CLR: Stops trigger pulses with level triggering (PULSE). With edge triggering, an ongoing task is aborted. Abortion is also possible when selecting the trigger sources MFI and SyncIO.

A 3.2.4 Interfaces

A 3.2.4.1 BAUDRATE, RS422

```
BAUDRATE 9600|115200|230400|460800|691200|921600|2000000|3000000|4000000
```

Set the baud rate for the RS422 interface.

A 3.2.4.2 ERROROUT1/2, Activate Switching Output

```
ERROROUT1 DIST|TEACH|LI1
```

```
ERROROUT2 DIST|TEACH|LI1
```

Choose error signal of the ERROR switching output.

- DIST: no peak found or beyond measuring range (out of range)
- TEACH: Distance is out of scaled analog range
- LI1: Distance is greater than the limit value (ERRORLIMIT)

A 3.2.4.3 ERRORLEVELOUT1/2, Output Level Switching Output

```
ERRORLEVELOUT1 NPN|PNP|PUSHPULL|PUSHPULLNEG
```

```
ERRORLEVELOUT2 NPN|PNP|PUSHPULL|PUSHPULLNEG
```

Choice of output level for ERROROUT1.

- NPN: switching output is active in case of an error
- PNP: switching output is active in case of an error
- PUSHPULL: switching output is high in case of an error
- PUSHPULLNEG: switching output is low in case of an error

Wiring of ERROR1 switching output, see [Chap. 5.4.8](#).

A 3.2.4.4 ERRORLIMITCOMPARETO1/2

```
ERRORLIMITCOMPARETO1 [LOWER|UPPER|BOTH]
```

```
ERRORLIMITCOMPARETO2 [LOWER|UPPER|BOTH]
```

Defines the monitoring function for the switching outputs.

- LOWER: Monitors if the measurement value falls short of the limit value
- UPPER: Monitors if the measurement value exceeds the limit value
- BOTH: Monitors excess/shortfall of limit values.

A 3.2.4.5 ERRORLIMITVALUES1/2

```
ERRORLIMITVALUES1 [<lower limit [mm]> [<upper limit [mm]>]]
```

```
ERRORLIMITVALUES2 [<lower limit [mm]> [<upper limit [mm]>]]
```

Defines the lower and upper limit value for the switching outputs.

Value range:

- <lower limit [mm]> = (-2 ... 2) * measuring range [mm]
- <upper limit [mm]> = (-2 ... 2) * measuring range [mm]

A 3.2.4.6 ERRORHYSTERESIS

```
ERRORHYSTERESIS <hysteresis [mm]>
```

Value by which the measured value must fall short of the limit value to deactivate the switching output.

Value range: -2 ... +2 * measuring range [mm].

A 3.2.4.7 ERROROUTHOLD

```
ERROROUTHOLD <hold period>
```

Indicates in ms how long the switching output must be active at least when the limit value is exceeded. This time period starts when the limit value is exceeded. Range: 0....1000 [ms].

A 3.2.5 Handling of Setups

A 3.2.5.1 IMPORT

```
IMPORT [FORCE] [APPLY] <ImportData>
```

Import of data in JSON format to the sensor.

First, the import command returns a prompt (->). Afterwards, data can be sent. After importing a prompt (->) is returned.

- FORCE: Overwriting measurement settings (=MEASSETTINGS) with the same name (otherwise an error message is displayed when the name is the same). When importing all measurement settings or device settings (= BASICSETTINGS) FORCE must always be stated.
- APPLY : Activates the settings after importing / reading the Initial Settings.
- ImportData: Data in JSON format

A 3.2.5.2 EXPORT

```
EXPORT (MEASSETTINGS <SettingName>) | BASICSETTINGS | MEASSETTINGS_ALL | ALL
```

Export sensor settings.

- MEASSETTINGS: Only transmits measurement settings with the name <SettingName>.
- BASICSETTINGS: Only transmits device settings.
- MEASSETTINGS_ALL: Transmits all measurement settings.
- ALL: Transmits all device and measurement settings.

A 3.2.5.3 MEASSETTINGS, Load / Save Measurement Settings

MEASSETTINGS <Subcommands> [<Name>]

Settings of the measurement task.

Definitions

- Setup: User-specific program with relevant settings for a measurement task
- Preset: Manufacturer-specific program with settings for frequent measurement tasks; cannot be overwritten
- Initial setup at boot (sensor start): a favorite can be selected from the setups, which is automatically activated at sensor start

Loads proprietary presets and user-specific settings from the sensor or stores user-specific setups in the sensor.

Subcommands:

- PRESETMODE: Returns the currently used Preset mode (signal quality). When a setup is used, the answer is NONE.
- PRESETMODE <mode>: Sets a preset mode (signal quality), <mode> = STATIC|BALANCED|DYNAMIC|NOAVERAGING
- PRESETLIST: Lists all existing manufacturer-specific programs. Sensor response: Standard | Multi-Surface | Light Penetration
- CURRENT: Returns the name of the currently used presets or setups.
- READ <Name>: Loads a preset or setups <Name> of non-volatile memory. The program is directly executed in the sensor. Note the upper and lower case of the program name
- STORE <Name>: Saves the current user-specific settings to a setup <Name> or a new setup <name> in a non-volatile memory.
- RENAME <NameOld> <NameNew> [FORCE]: Renaming measurement setting. An existing measurement setting can be overwritten with FORCE.
- DELETE <Name>: Deletes a setup.
- INITIAL AUTO: Loads the last saved setup or preset used when starting the sensor
- INITIAL <Name>: Determines the setup <Name> for the next sensor start. Presets cannot be indicated.
- INITIAL: Returns the name of the setup intended for the next start of the sensor. Alternatively, the sensor responds with MEASSETTINGS INITIAL AUTO when this command had been sent before.
- LIST: Returns the names of all saved setups.

A 3.2.5.4 BASICSETTINGS, Load / Save Device Settings

BASICSETTINGS READ | STORE

- READ: Loads the stored device settings from the sensor.
- STORE : Saves the current device settings in the sensor.

A 3.2.5.5 SETDEFAULT, Factory Settings

SETDEFAULT ALL | MEASSETTINGS | BASICSETTINGS

Resets the sensor to factory settings.

- ALL: Deletes measurement and device settings and loads the standard preset for the measurement settings or the default parameters for the device settings.
- MEASSETTINGS: Loads the measurement settings and deletes the standard presets loaded.
- BASICSETTINGS: Deletes the device settings and loads the default parameters.

A 3.2.6 Analog Output

A 3.2.6.1 ANALOGRANGE

```
ANALOGRANGE [0-5V|0-10V|4-20mA]
```

Sets the type of the analog output.

A 3.2.6.2 ANALOGSCALEMODE, Scaling the Analog Output

```
ANALOGSCALEMODE STANDARD|TWOPOINT
```

Choice of the scaling type of the analog output.

- STANDARD: using the measuring range of the sensor
- TWOPOINT: two-point scaling within the analog range
 - Minimum value: measurement value in mm which is matched to the lower analog value,
 - Maximum value: measurement value in mm which is matched to the upper analog value.

i The minimum value (in mm) can be higher than the maximum value (in mm), see [Chap. 7.6.3](#).

A 3.2.6.3 ANALOGSCALERANGE, Scaling Limits with Two-Point Scaling

```
ANALOGSCALERANGE <limit 1> <limit 2>
```

Sets the scaling limits of the analog output with two-point scaling.

<limit 1> = (-2 ... 2) * measuring range [mm]

<limit 2> = (-2 ... 2) * measuring range [mm]

The scaling limits must not be identical.

A 3.2.6.4 ANALOGSCALESOURCE

```
ANALOGSCALESOURCE NONE | MFI | KEY_SELECT
```

Determination of the port for teaching.

- NONE: No port selected.
- MFI: Switching input triggers teaching function.
- KEY_SELECT: The Select key triggers the teaching function.

A 3.2.7 Key Function

A 3.2.7.1 KEYLOCK, Set Key lock

```
KEYLOCK NONE | ACTIVE | AUTO [<timeout period>]
```

Key lock configuration

- NONE: Key is active, no key lock
- ACTIVE: Key lock is activated immediately after restart
- AUTO: Key lock is only activated <timeout period>, 1 ... 60 minutes after reboot

A 3.2.8 Measurement

A 3.2.8.1 TARGETMODE, Measurement Task

```
TARGETMODE STANDARD | MULTISURFACE | PENETRATION
```

Choice of material dependent presets

- STANDARD: suitable for materials, e.g. made of ceramics, metal, plastics or wood
- MULTISURFACE: suitable for materials with changing surfaces, e.g. PCB or hybrid materials
- PENETRATION: suitable for materials with strong penetration depth of the laser light

A 3.2.8.2 MEASPEAK, Choice of the Peak in the Video Signal

```
MEASPEAK DISTA | DISTW | DIST1 | DISTL
```

- DISTA: output of peak with highest amplitude (standard)
- DISTW: output of peak with the largest area
- DIST1: output of first peak
- DISTL: output of last peak

A 3.2.8.3 MEASRATE, Measuring Rate

```
MEASRATE <frequency>
```

Specifies the measuring rate in kHz, range 0.25 ... 10 kHz.

A 3.2.8.4 SHUTTER, Exposure Time

```
SHUTTER <exposure time>
```

Sets the exposure time to a fixed value with manual exposure time.

The maximum exposure time is the reciprocal of the measuring rate. Therefore, the manual exposure time is smaller than/equal to the maximum exposure time.

The exposure time is indicated in μs . Range: 1 ... 4000 μs , increments of 0.1 μs

A 3.2.8.5 SHUTTERMODE

```
SHUTTERMODE MEAS | MANUAL
```

MEAS: Exposure time is controlled automatically

MANUAL: Selectable exposure time

A 3.2.8.6 EXPOSUREMODE

```
EXPOSUREMODE STANDARD | INTELLIGENT | BACKGROUND
```

The command sets the behavior for automatic exposure time regulation.

- STANDARD: exposure time is set depending on the target reflectivity
- INTELLIGENT: beneficial when measuring moving objects or material transitions
- BACKGROUND: suppresses interferences caused by ambient light, the sensor's output rate is reduced by half.

A 3.2.8.7 LASERPOW, Laser Power

```
LASERPOW FULL | REDUCED | OFF
```

- FULL: Laser power is switched to 100%
- REDUCED: Laser power is switched to 50%
- OFF: Laser is switched off.

A 3.2.8.8 ROI, Video Signal, Masking the Evaluation Range

```
ROI <Start> <End>
```

Sets the evaluation range for „Region of interest“. Start and end must be between 0 and 511. The “start” value is smaller than the “end” value.

A 3.2.8.11 MASTER

```
MASTER [DIST1]
MASTER ALL|DIST1 SET|RESET
```

The function uses the measurement value (DIST1) in order to generate an offset. This offset is then applied to the following measurement values.

Example: Zero is defined as master value, DIST1 currently provides 0.5 mm as measured value. Therefore, -0.5 mm is applied as offset to DIST1.

The Reset function resets the offset to zero.

The output lists the values and the word ACTIVE when mastering is currently used or the word INACTIVE without mastering.

A 3.2.8.12 MASTERSIGNAL

```
MASTERSIGNAL DIST1
MASTERSIGNAL DIST1 <master value>
MASTERSIGNAL DIST1 NONE
```

- <master value>: value in mm, value range -2 ... +2 * Measuring range

Displays, changes or deletes the master value. The master value is calculated with the current measurement value when mastering is active. Mastering can be triggered with the command `MASTER`.

If the master value is 0, the mastering function has the same functionality as the zero setting.

The output lists signals and the currently used master value.

A 3.2.8.13 MASTERSOURCE

```
MASTERSOURCE NONE | MFI | KEY_SELECT
```

Choice of port for mastering.

- NONE: No port (hardware) selected, mastering is possible via command.
- MFI: Use switching input in order to trigger mastering.
- KEY_SELECT: Use Select key in order to trigger mastering.

A 3.2.9 Data Output

A 3.2.9.1 OUTPUT, Selection of Measurement Value Output

```
OUTPUT NONE | ([RS422 | ANALOG] [ERROROUT1 | ERROROUT2 | ERROROUT1 ERROROUT2])
```

- NONE: No measurement value output
- RS422: Output of measurement values via RS422
- ANALOG: Output of measurement values via analog output
- ERROROUT1/2: Output of an error/status information via the switching outputs.

A parallel output of measured values via multiple channels is not possible. RS422 and analog output cannot be operated simultaneously.

A 3.2.9.2 OUTREDUCEDEVICE, Output Reduction of Measurement Value Output

```
OUTREDUCEDEVICE NONE | ([RS422] [ANALOG])
```

Selection of interface for data reduction.

- NONE: no data reduction
- RS422: output reduction for RS422
- ANALOG: output reduction for analog output

A 3.2.9.3 OUTREDUCECOUNT, Data Output Rate

```
OUTREDUCECOUNT <n>
```

Reduces the measured value output for all selected interfaces.

- 1: outputs each measurement value
- 2 ... 3000000: output of each n-th measured value

A 3.2.9.4 OUTHOLD, Error Processing

```
OUTHOLD NONE | INFINITE | <n>
```

Setting the behavior of the measurement value output in case of error.

- NONE: No holding of the last measured value, output of error value.
- INFINITE: Infinite holding of the last measurement value.
- <n>: Holding the last measured value over a number of measuring cycles n; then an error value is output. n = (1 ... 1024).

A 3.2.9.5 GETOUTINFO_RS422, Query Selected Data

```
GETOUTINFO_RS422
```

The command lists all output data chosen for the RS422 interface. The displayed order corresponds to the output sequence.

A 3.2.9.6 List of Possible RS422 Signals

```
META_OUT_RS422
```

List of possible data for RS422.

A 3.2.9.7 OUT_RS422

```
OUT_RS422 ([DIST1] [SHUTTER] [COUNTER] [TIMESTAMP_LO] [TIMESTAMP_HI] [INTENSITY] [STATE]  
[TRIGGEREVENTCOUNTER] [TRIGGERVALUECOUNTER] [UNLIN] [VIDEO] [MEASRATE])
```

This is the main group, where all available signals can be selected for output over RS422 (serial interface).

- DIST1: Calibrated distance value
- SHUTTER: exposure time
- COUNTER: measured value counter
- TIMESTAMP_LO: Time stamp (16 Bit lower word)
- TIMESTAMP_HI: Time stamp (16 Bit upper word)
- INTENSITY: intensity
- STATE: Status word
- TRIGGEREVENTCOUNTER: Trigger event counter
- TRIGGERVALUECOUNTER: Trigger value counter
- UNLIN: Non-calibrated distance value (raw value)
- VIDEO: video signal (raw value)
- MEASRATE: measuring rate (frequency)

A 3.3 Example Command Sequence During Selection of Measurement Value

| Command | Content |
|-----------------|--|
| MEASPEAK | Peak selection with distance measurement |
| MEASRATE | Measuring rate (by taking into consideration reflectivity and movement of the target) |
| COMP | Averaged measurements (by taking into consideration reflectivity, structure and movement of the target) |
| OUTPUT | Selection of the output channel |
| OUTREDUCEDEVICE | Reduction of the output data rate (under consideration of the chosen output channel, its settings and the processing range of the target system) |
| OUTREDUCECOUNT | |
| OUTHOLD | Output behavior in the event of measuring errors |
| OUT_RS422 | Selection of the additional values to be output for RS422 interface |
| BAUDRATE | Baud rate setting RS422 interface |

A 3.4 Error Messages

If an error occurs with a command, the error message is listed.

| Error message | Description |
|--|--|
| E100 Internal error | Internal error code |
| E104 Timeout | Timeout with mastering. |
| E200 I/O operation failed | Cannot write data on output channel. |
| E202 Access denied | Access denied; requires login as expert. |
| E204 Received unsupported character | An unsupported character was received. |
| E210 Unknown command | Unknown command (insufficient rights for reading). |
| E214 Entered command is too long to be processed | The indicated command with the parameters it too long (larger than 255 bytes). |
| E220 Timeout, command aborted | Timeout with mastering. |
| E232 Wrong parameter count | Too high or small number of parameters. |

| | |
|---|---|
| E234 Wrong or unknown parameter type | A transmitted parameter has a wrong type or a wrong number of parameters were transmitted. |
| E236 Value is out of range or the format is invalid | The parameter value is outside the range of values. |
| E262 Active signal transfer, please stop before | One measurement data output is active. End the measurement data output in order to execute the command. |
| E320 Wrong info-data of the update | Only with update: The header of the update data contains an error. |
| E321 Update file is too large | Only with update: The update is too large. |
| E322 Error during data transmission of the update | Only with update: Error with transmission of update data. |
| E323 Timeout during the update | Only with update: Timeout with transmission of update data. |
| E331 Validation of import file failed | Import file is invalid |
| E332 Error during import | Error with processing import data. |
| E333 No overwrite during import allowed | No overwrite of measurement and device settings allowed through import. Setting checkbox. |
| E350 The new passwords are not identical | Error with repeated entry of new password. |
| E360 Name already exists or not allowed | The measurement setting name already exists or is not allowed. |
| E361 Name begins or ends with spaces or is empty | Name for the measurement setting begins or ends with spaces or is empty. |
| E362 Storage region is full | Number of storable measurement settings is reached |
| E363 Setting name not found | Name of the measurement setting to be loaded not found |
| E364 Setting is invalid | Measurement or device setting is invalid |
| E600 ROI begin is greater than ROI end | Start of the evaluation range is larger than the end. |
| E602 Master value is out of range | The master value is outside the valid range. |
| E616 Software triggering is not active | Software trigger is not active. |

| Warning | Description |
|---|--|
| W320 The measuring output has been adapted automatically. | The measurement value output has been adapted automatically. |
| W570 The input has been adapted automatically to a limited range. | The input has been adapted automatically to a limited range. |

A 4 Control Menu

A 4.1 Tab Home

| | | | |
|------------------|---------|--|---|
| Measurement task | Presets | <i>Standard</i> | <i>Suitable for materials made of ceramics, metal or filled plastics</i> |
| | | <i>Multi-Surface</i> | <i>Suitable for printed circuit boards, hybrid material</i> |
| | | <i>Light penetration</i> | <i>Suitable for plastics, materials with large penetration depth of the laser</i> |
| | Setups | <i>Setup 1 ... Setup 8</i> | <i>Setups contain user-specific measurement settings. Unlike the presets they can be changed anytime.</i> |
| Signal quality | | Static / balanced / dynamic / no averaging | <i>The signal quality affects averaging of measurement values.</i> |

A 4.2 Tab Settings

A 4.2.1 Inputs

| | | | | |
|----------------------------|------------------------------------|-------------|--|--|
| Laser power | <i>Full / Reduced / Off</i> | | <i>Full power for standard surfaces</i> | <i>The laser light source is active only, if pin 9 is connected to GND.</i> |
| | <i>Medium ¹</i> | | <i>Optimized power for strongly reflective</i> | |
| | <i>Reduced</i> | | <i>Minimum power for service</i> | |
| | <i>Off</i> | | <i>Laser is off</i> | |
| Synchronization | <i>Slave / Slave alternating</i> | Termination | <i>On / Off</i> | <i>If several sensors measure the same target synchronously, the sensors may be synchronized with each other. The synchronization output of the first sensor (master) controls the sensors connected to the synchronization inputs (slaves).</i> |
| | <i>Slave MFI</i> | | | |
| | <i>Master / Master alternating</i> | | | |
| | <i>inactive</i> | | | |
| Level Multi-function input | <i>TTL / HTL</i> | | <i>Defines the input level of both switching inputs Laser on/off and Multi-function.</i> <i>TTL: Low ≤ 0.8 V; High ≥ 2V</i> <i>HTL: Low ≤ 3 V; High ≥ 8V</i> | |

i Pay attention to the signal intensity when switching the laser power. You achieve best possible results with a signal intensity of 25 ... 50 %.

1) The Medium laser power function is only available from firmware 004.004.

A 4.2.2 Data Recording

| | | | | | |
|---|--|---------------------------|-------------------------------------|---|--------------------------------|
| Measuring rate | 250 Hz / 500 Hz / 1 kHz / 2 kHz / 4 kHz / 8 kHz / 10 kHz | | | Use a high measuring rate for bright and mat measurement objects. Use a low measuring rate for dark or shiny measurement objects (e.g. black painted surfaces) to improve the measurement result. | |
| | Free measuring rate | Value | | | |
| Input trigger Output trigger Trigger source | Multi-function input / Synchronization input | Trigger type | Edge / Level | | |
| | | Trigger level | high rising edge / low falling edge | | |
| | | Number of measured values | Infinite | | |
| | Manual selection | | Value | Range: 1 ... 16383 | |
| | Software | Number of measured values | Infinite | | |
| | | | Manual selection | Value | Range: 1 ... 16383 |
| | | Start triggering | | | Button starts data recording |
| | | Stop triggering | | | Sensor outputs continuous data |
| Inactive | | | No triggering | | |
| Masked area | Start of range | 0 ... 99 % | Value | Setting the evaluation range for the „Region of interest“, i.e. only this range is used for logging the measuring values. The Start of range value has to be smaller than the End of range value. | |
| | End of range | 1 ... 100 % | Value | | |

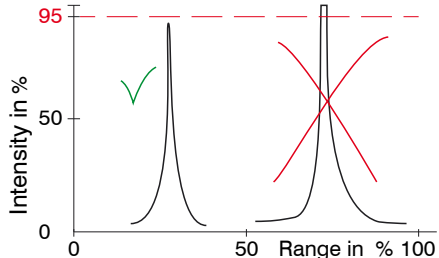
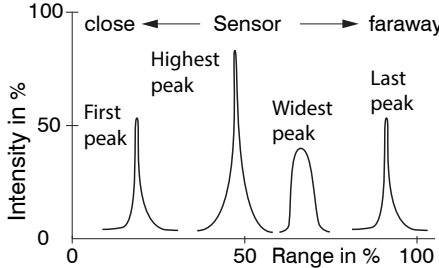
| | | | |
|-----------------------|--|--|---|
| <p>Exposure mode</p> | <p>Automatic mode / Manual mode</p> | <p>In the automatic mode, the sensor determines the optimal exposure time in order to achieve the highest possible signal intensity. In the manual mode, when the video signal is displayed, the user determines the exposure time Vary the exposure time in order to achieve a signal quality up to a maximum of 95 %. In both cases, the set measuring rate is hold.</p> |  |
| <p>Peak selection</p> | <p>First peak / Highest peak / Last peak / Widest peak</p> | <p>Defines which signal is used for the evaluation in the line signal. First peak: Nearest peak to sensor. Highest peak: standard, peak with the highest intensity. Last peak: widest peak to sensor. Widest peak: peak with maximum area.</p> |  |
| <p>Error handling</p> | <p>Digital output, no value</p> <p>Hold last value infinite</p> <p>Hold last value</p> | <p>The analog output supplies 3 mA resp. 5.2 / 10.2 V instead of measurement value. The RS422 interface outputs an error value.</p> <p>Analog output and RS422 interface stop at the last valid value.</p> <p>1 ... 1024 Value</p> | |

A 4.2.3 Signal Processing

| | | | | |
|----------------------------|-------------------------------|-------------------------------------|-------|--|
| Averaging | <i>Inactive</i> | | | <i>Measurement values are not averaged.</i> |
| | Moving N values | 2 / 4 / 8 ... 4096 | Value | <i>Indication of averaging mode. The averaging number N indicates the number of consecutive measurement values to be averaged in the sensor.</i> |
| | Recursive N values | 2 ... 32000 | Value | |
| | Median N values | 3 / 5 / 7 / 9 | Value | |
| Zero setting/ Mastering | Select source | <i>Inactive</i> | | <i>Normal measurement value resp. Zeroing/Mastering is undone.</i> |
| | | Select button / Multifunction input | | <i>Select control element for mastering.</i> |
| | Master value | Value | | <i>Indication e.g. of thickness of a master part. Value range -2 up to max. +2 x measuring range</i> |
| | Set master value | | | <i>Adopts the master value but does not execute it.</i> |
| | Activate master value / reset | | | <i>Mastering/reset is done via buttons in the web interface.</i> |
| Data reduction | Value | | | <i>Indicates the sensor which data is to be excluded from output, thus the data amount to be transmitted is reduced.</i> |
| Reduction relates to | RS422 / Analog | | | <i>Interfaces to be used for undersampling are to be selected via the checkbox.</i> |

A 4.2.4 Outputs

| | | | | | |
|---|-------------------|--|-----------|-------|---|
| RS422 | Baud rate | 9.6 / 115.2 / 230.4 / 460.8 / 691.2 / 921.6 / 2000 / 3000 / 4000 kbps | | | Transmission speed, binary data format |
| | Output data | Distance / Non-linearized center of gravity / Intensity / Exposure time / Sensor state / Measurement counter / Time stamp / Video signal | | | Data to be transmitted are to be activated via the checkbox. |
| Analog output | Output range | 0-5 V / 0-10 V / 4-20 mA | | | Select voltage or current output |
| | Scaling | Standard scaling | | | Start of measuring range 0 V oder 4 mA, End of measuring range 5 V/10 V / 20 mA |
| | | Two-point scaling | Minimum | Value | Always 2 points are taught which mark start and end of new measuring range. With two point scaling reversal of the output signal is possible |
| | | | Maximum | Value | |
| Digital outputs (switching outputs) 1 / 2 | Configuration | Full scale error / Distance is outside the analog range / Distance is out of limit | | | Regulates the switching performance of the switching (digital) output (Error), see Chap. 5.4.8 . Range limit values: -2 ... +2 x Measuring range The minimum hold time defines how long the output must be active at least. The hysteresis defines a dead band around the selected limit values. |
| | Compare to limit | Lower / Upper / Both | Limit min | Value | |
| | | | Limit max | Value | |
| | Switching level | NPN / PNP / PushPull / PushPull negative | | | |
| | Minimum hold time | 1 ... 1000 ms | Value | | |
| | Hystereses | 0 ... 2 x Measuring range | Value | | |

| | | |
|------------------|---|---|
| Output interface | RS422 / Analog output / digital output 1 (switching output 1) / digital output 2 (switching output 2) | <i>Defines which interface is used for output of measured values. A parallel output of measured values via multiple channels is not possible. RS422 and analog output cannot be operated simultaneously. The switching outputs 1 and 2 can be activated regardless of any other channel. While using the web interface, the output is switched off via RS422.</i> |
|------------------|---|---|

A 4.2.5 System Settings

| | | | | |
|--------------------|----------------------|---|--|--|
| Unit web interface | <i>mm / Inch</i> | | <i>Unit in measurement value display</i> | |
| Key lock | <i>Automatic</i> | <i>Countdown 1 ... 60 [min]</i> | <i>Value</i> | <i>The key lock starts after expiry of the defined time. Clicking the button Refresh extends the interval until key lock starts.</i> |
| | | <i>Refresh</i> | | |
| | <i>Active</i> | | <i>The keys do not respond in any user level</i> | |
| | <i>Inactive</i> | | <i>The keys are active in any user level</i> | |
| Load & Store | Measurement settings | <i>New setup / Setup 1 / ... / Setup 8</i> | <i>Load</i> | <i>Activates a saved measurement setting setup.</i> |
| | | | <i>Safe</i> | <i>Saves changed measurement settings to an existing setup.</i> |
| | | | <i>Favorite</i> | <i>Selects a setup which is used after reboot of the sensor.</i> |
| | | | <i>Delete</i> | <i>Deletes a setup.</i> |
| | | | <i>Search</i> | <i>You load an existing setup from a PC or the like to the ILD1900 with both buttons.</i> |
| | | | <i>Import</i> | |
| | | | <i>Export</i> | <i>Saves the setup on a connected PC or the like.</i> |
| | | | Device settings | <i>Create setup</i> |
| | <i>Safe</i> | <i>Saves changed device settings.</i> | | |
| | <i>Search</i> | <i>You load the device settings from a PC or the like to the ILD1900 with both buttons.</i> | | |
| | <i>Import</i> | | | |
| | <i>Export</i> | <i>Saves the device settings on a connected PC or the like.</i> | | |

| | | | | | |
|---------------------|---|-----------------------------|--|--|--|
| Import & Export | Create a parameter set | <i>Measurement settings</i> | | <i>The measurement setting setups, the file with device settings and the boot file can be combined in one parameter set and exchanged with a PC or the like.</i> | |
| | | <i>Boot setup</i> | | | |
| | | <i>Device settings</i> | | | |
| | Search | | <i>Button starts file manager to select a parameter set.</i> | | |
| Check file | <i>Overwrite existing setups (with the same name)</i> | | <i>Dialog prevents inadvertent overwriting of existing settings.</i> | | |
| | <i>Apply settings of the imported boot setup</i> | | | | |
| | <i>Transmit data</i> | | | | |
| Access permission | Current access permission | <i>Value</i> | | <i>Read only</i> | |
| | Logout / Login | | | <i>Button starts change of access permission.</i> | |
| | User level when restarting | <i>Professional / User</i> | | <i>Sets the user level the sensor starts with after reboot. In this case Micro-Epsilon recommends the selection user.</i> | |
| | Change password | Old password | <i>Value</i> | | <i>Case-sensitive rules are observed for all passwords. Numbers are allowed. Special characters are not allowed. Maximum length is limited to 31 characters.</i> |
| | | New password | <i>Value</i> | | |
| Repeat new password | | <i>Value</i> | | | |
| Change password | | | <i>Button causes change of password.</i> | | |

| | | |
|--------------|----------------------|---|
| Reset sensor | Measurement settings | <i>The settings for measuring rate, trigger, evaluation range, selection of peak, error handling, averaging, Zeroing/Mastering, reduction of data and setups are deleted. The 1st preset is loaded.</i> |
| | Device settings | <i>The settings baud rate, language, unit, key lock and echo mode are deleted and the default parameters are loaded.</i> |
| | Reset all | <i>By clicking the button the settings for the sensor, measurement settings, access permission, password and setups are deleted. The 1st preset is loaded.</i> |
| | Restart sensor | <i>By clicking the button the sensor is rebooted with the settings made in the favorite setup, see Chap. 7.7.4.</i> |

Selection required or checkbox

Fields with dark border require entry of a value.

i After the programming all settings must be permanently stored under a parameter set so that they are available again when the sensor is switched on the next time.



MICRO-EPSILON MESSTECHNIK GmbH & Co. KG
Koenigbacher Str. 15 · 94496 Ortenburg / Germany
Tel. +49 (0) 8542 / 168-0 · Fax +49 (0) 8542 / 168-90
info@micro-epsilon.com · www.micro-epsilon.com
Your local contact: www.micro-epsilon.com/contact/worldwide/

X9751416-B042104MSC
© MICRO-EPSILON MESSTECHNIK