



Operating Instructions

capa**NCDT** 6110/6112/6120

CS005
CS02
CS05
CS08
CS1
CS1HP
CS2

CS3
CS5
CS10
CSH02
CSH02FL
CSH05
CSH05FL

CSH1
CSH1FL
CSH1,2
CSH1,2FL
CSH2FL
CSH3FL
CSH2

CSE05
CSE05/M8
CSE1
CSE1,25/M12
CSE2
CSE2/M16
CSE3/M24

Non-contact Capacitive Displacement Measuring

MICRO-EPSILON
MESSTECHNIK
GmbH & Co. KG
Königbacher Straße 15

94496 Ortenburg / Germany

Tel. +49 (0) 8542 / 168-0
Fax +49 (0) 8542 / 168-90
e-mail info@micro-epsilon.de
www.micro-epsilon.com

Contents

1.	Safety	5
1.1	Symbols Used	5
1.2	Warnings	5
1.3	Notes on CE Marking	6
1.4	Intended Use	7
1.5	Proper Environment	7
2.	Functional Principle, Technical Data	8
2.1	Measuring Principle	8
2.2	Structure	9
	2.2.1 Sensors	11
	2.2.2 Sensor Cable	12
	2.2.3 Controller	13
2.3	Technical Data	14
3.	Delivery	15
3.1	Unpacking	15
3.2	Storage	15
4.	Installation and Assembly	16
4.1	Precautionary Measures	16
4.2	Sensor	16
	4.2.1 Radial Point Clamping, Circumferential Clamping, Cylindric Sensors	16
	4.2.2 Mounting with Thread, Series CSEx/Mx Sensors	17
	4.2.3 Flat Sensors	18
	4.2.4 Dimensional Drawings Sensors	19
4.3	Sensor Cable	25
	4.3.1 General	25
	4.3.2 Cable with Type C Connector	25
	4.3.3 Cable with Type B Connector	26
4.4	Controller	27
4.5	Ground Connection, Earthing	28
4.6	Power Supply, Display/Output Device DT6110	28
4.7	Power Supply, Display/Output Device DT6120	29
4.8	Sensor Connection	29

5.	RS485 Interface	30
5.1	Hardware Interface	30
5.2	Protocol.....	30
	5.2.1 Reading Measuring Values	31
	5.2.2 Scaling the Measuring Values.....	32
	5.2.3 Example of the Measuring Value Transmission	33
	5.2.4 Setting the RS485 Address	35
5.3	Commands and Settings.....	36
6.	Operation	37
7.	Maintenance	38
8.	Liability for Material Defects.....	39
9.	Decommissioning, Disposal	39
Appendix		
A 1	Optional Accessories.....	40
A 2	Tilt Angle Influence on the Capacitive Sensor	43
A 3	Measurement on Narrow Targets	44
A 4	Measurements on Balls and Shafts	45

1. Safety

Knowledge of the operating instructions is a prerequisite for equipment operation.

1.1 Symbols Used

The following symbols are used in this instruction manual:



Indicates a hazardous situation which, if not avoided, may result in minor or moderate injury.



Indicates a situation that may result in property damage if not avoided.



Indicates a user action.



Indicates a tip for users.

1.2 Warnings



Disconnect the power supply before touching the sensor surface.

> Risk of injury

> Static discharge

Connect the power supply and the display/output device in accordance with the safety regulations for electrical equipment.

> Risk of injury

> Damage to or destruction of the sensor and/or controller



Avoid shocks and impacts to the sensor and controller.

> Damage to or destruction of the sensor and/or controller

The power supply must not exceed or continuously fall below the specified limits.

> Damage to or destruction of the sensor and/or controller

Protect the sensor cable against damage

> Destruction of the sensor

> Failure of the measuring device

1.3 Notes on CE Marking

The following apply to the capaNCDT 6110 / 6120:

- EU directive 2014/30/EU
- EU directive 2011/65/EU, "RoHS" category 9

Products which carry the CE mark satisfy the requirements of the EU directives cited and the European harmonized standards (EN) listed therein. The EU Declaration of Conformity is available to the responsible authorities according to EU Directive, article 10, at:

MICRO-EPSILON Messtechnik GmbH & Co. KG
Königbacher Straße 15
94496 Ortenburg / Germany

The measuring system is designed for use in industrial environments and meets the requirements.

1.4 Intended Use

- The capaNCDT 6110 / 6120 measuring system is designed for use in industrial areas. It is used for
 - displacement, distance, thickness and movement measurement
 - position measuring of parts or machine components
- The system must only be operated within the limits specified in the technical data, see Chap. 2.3.
- The system must be used in such a way that no persons are endangered or machines and other material goods are damaged in the event of malfunction or total failure of the system.
- Take additional precautions for safety and damage prevention in case of safety-related applications.

1.5 Proper Environment

- Protection class: IP 40
- Operating temperature:
 - Sensor: -50 ... +200 °C (-58 to +392 °F)
 - Sensor cable: -100 ... +200 C (-58 to +392 °F) (CCx, CCx/90, CCmx and CCmx/90)
-20 ... +80 °C (-4 to 176 °F) (CCgx and CCgx/90 - permanently)
-20 ... +100 °C (-4 to 212 °F) (CCgx and CCgx/90 - 10,000 h)
 - Controller: +10 ... +60 °C (-50 to +140 °F)
- Humidity: 5 - 95 % (non-condensing)
- Ambient pressure: Atmospheric pressure
- Storage temperature:
 - Sensor: -50 ... +200 °C (-58 to +392 °F)
 - Sensor cable: -50 ... +200 °C (-58 to +392 °F) (CCx, CCx/90, CCmx und CCmx/90)
-50 ... +80 °C (-58 to +176 °F) (CCgx and CCgx/90)
 - Controller: -10 ... +75 °C (+14 to +167 °F)
- The space between the sensor surface and the target must have an unvarying dielectric constant.
- The space between the sensor surface and the target may not be contaminated (for example water, rubbed-off parts, dust, etc.).

2. Functional Principle, Technical Data

2.1 Measuring Principle

The principle of capacitive distance measurement with the capaNCDT system is based on the principle of the parallel plate capacitor. For conductive targets, the sensor and the target opposite form the two plate electrodes.

If a constant AC current flows through the sensor capacitor, the amplitude of the AC voltage at the sensor is proportional to the distance between the capacitor electrodes. The AC voltage is demodulated, amplified and output as an analog signal.

The capaNCDT system evaluates the reactance X_C of the plate capacitor which changes strictly in proportion to the distance.

$$X_C = \frac{1}{j\omega C}; \quad \text{capacitance } C = \epsilon_r * \epsilon_o * \frac{\text{area}}{\text{distance}}$$

i A small target and bent (uneven) surfaces cause a non-linear characteristic.

This theoretical relationship is realized almost ideally in practice by designing the sensors as guard ring capacitors.

The linear characteristic of the measuring signal is achieved for electrically conductive target materials (metals) without any additional electronic linearization. Slight changes in the conductivity or magnetic properties do not affect the sensitivity or linearity.

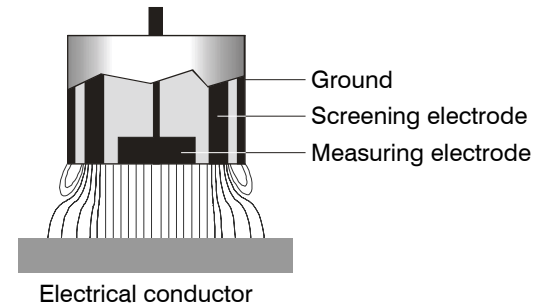

Fig. 1 Functional principle of the guard ring capacitor

2.2 Structure

The non-contact, single-channel measuring system of capaNCDT 6110 / 6120, installed in an aluminum housing, consists of:

- Controller
- Sensor
- Sensor cable
- Power supply and signal cable

The signal processing electronics with oscillator, demodulator, AD converter and integrated preamplifier is in the controller ¹.

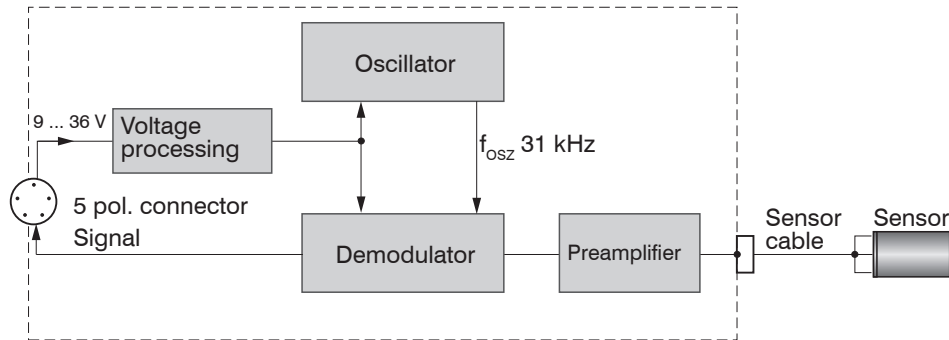

Fig. 2 Block diagram capaNCDT 6110

1) The controller 6120: Contains additionally an AD converter for converting to a RS485 interface.

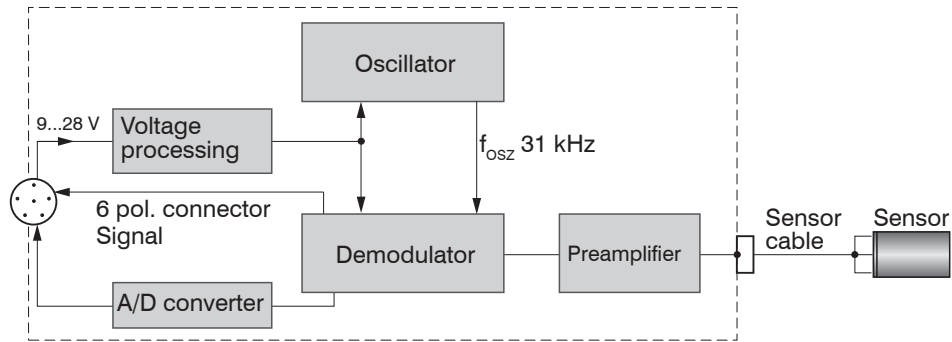

Fig. 3 Block diagram capaNCDT 6120

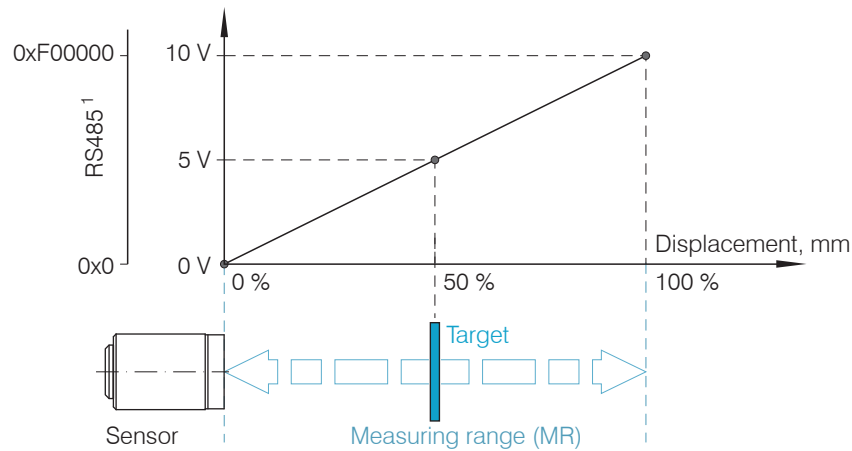

Fig. 4 Glossary, signal output

1) With controller DT6120 or DT6120/ECL2 only

2.2.1 Sensors

For this measurement system, several sensors can be used.

► In order to obtain accurate measuring results, keep the surface of the sensor clean and free from damage.

The capacitive measuring process is area-related. A minimum area, see Fig. 5, is required depending on the sensor model and measuring range.

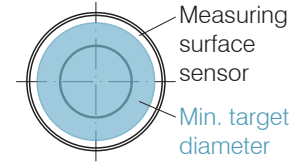

Sensor model	Measurng range, nominal	Min. target diameter
CS005	0.05 mm	3 mm
CS02	0.2 mm	5 mm
CSH02 CSH02FL	0.2 mm	7 mm
CSE05 CSE05/M8	0.5 mm	6 mm
CS05 CSH05 CSH05FL	0.5 mm	7 mm
CS08	0.8 mm	9 mm
CSE1	1 mm	8 mm
CS1 CS1HP	1 mm	9 mm
CSH1 CSH1FL	1 mm	11 mm
CSH1,2 CSH1,2FL	1.2 mm	11 mm
CSE1,25/M12	1.25 mm	10 mm
CSE2 CSE2/M16	2 mm	14 mm
CS2 CSH2 CSH2FL	2 mm	17 mm
CSE3/M24	3 mm	20 mm
CSH3FL	3 mm	24 mm
CS3	3 mm	27 mm
CS5	5 mm	37 mm
CS10	10 mm	57 mm

Fig. 5 Sensors for electrical conducting targets (metals)

2.2.2 Sensor Cable

Sensor and controller are connected by a special, double screened sensor cable.

Do not shorten or lengthen these special cables.

Usually, a damaged cable can not be repaired.

NOTICE

Switch off the device when plugging and removing connectors.

Do not crush the sensor cable.

Do not modify to the sensor cable.

> Lost of functionality

2.2.3 Controller

The capaNCDT 6110 / 6120 contains a voltage processing, oscillator, integrated preamplifier, demodulator ² as well as an output level.

The voltage processing produces all necessary internal voltages from the power supply. The oscillator supplies the sensor with frequency and amplitude-stabilized alternating voltage. The frequency is 31 kHz. The internal preamplifier generates the distance-dependent measuring signal and amplifies it. Demodulator and output level convert the measuring signal into a standard voltage signal ³.

NOTICE

The output voltage can reach up to a maximum of 13 VDC when sensor is disconnected or measurement is exceeded.

> Damage to downstream devices



Fig. 6 Controller DT6110 / 6120

2) The controller 6120: Contains additionally an AD converter.

3) An analog-digital converter converts the measuring signal and outputs it to the RS485 interface.

2.3 Technical Data

Controller model		DT6110	DT6110/ECL2	DT6120	DT6120/ECL2	DT6112
Resolution static		0.01 % FSO				
Resolution dynamic		0.015 % FSO (1 kHz)				0.03 % FSO (20 kHz)
Bandwidth		1 kHz (-3 dB)				20 kHz (-3 dB)
Linearity (typical)		±0.05 % FSO				
Max. sensitivity deviation		±0.1 % FSO				
Long term stability		< 0.05 % FSO/month				
Synchronous operation		no				
Isolator measurement		no				
Temperature stability		200 ppm				
Operating temperature		-50 ... +200 °C (sensor)				
		+10 ... +60 °C (controller)				
Storage temperature		-10 ... +75 °C				
Power supply		24 VDC/55 mA (9 - 36 V)		24 VDC/60 mA (9 - 28 V)		24 VDC/55 mA (9 - 36 V)
Output	analog	0 ... 10 V (short-circuit proof), optional: ±5 V, 10 ... 0 V				
	digital	---	---	RS485, 230400 Baud (adjustable), 24 bit measuring values, max. 2 kSamples (adjustable)		---
Sensors		all sensors suitable				
Sensor cable max. length	CC	1.0 m	2.0 m	1.0 m	2.0 m	1.0 m
	CCm	1.4 m	2.8 m	1.4 m	2.8 m	1.4 m
	CCg	2.0 m	4,0 m	2.0 m	4.0 m	2.0 m
Protection class	Controller	IP 40				
	Sensors	when plugged in: IP 54				
Weight		165 g				

FSO = Full Scale Output

3. Delivery



3.1 Unpacking

- 1 Controller
- 1 Power supply and output cable SCAC3/5 (DT6110) or SCAC3/6 (DT6120)
- 1 Instruction Manual

Optional accessories:

- 1 Sensor
- 1 Sensor cable with connector
- 1 IF1032/ETH interface converter from analog (DT6110) or RS485 Ethernet (DT6120) on Ethernet/EtherCAT

Further optional accessories, see Chap. [A 1](#)

-  Remove the parts of the system carefully from the packaging and transport them in such a way that they are not damaged.
-  Check for completeness and shipping damages immediately after unpacking. In case of damage or missing parts, please contact the manufacturer or supplier.

3.2 Storage

- Storage temperature:
 - Sensor: -50 ... +200 °C (-58 to +392 °F)
 - Sensor cable: -50 ... +200 °C (-58 to +392 °F) (CCx, CCx/90, CCmx and CCmx/90)
-50 ... +80 °C (-58 to +176 °F) (CCgx and CCgx/90)
 - Controller: -10 ... +75 °C (+14 to +167 °F)
- Humidity: 5 - 95 % RH (non-condensing)

4. Installation and Assembly

4.1 Precautionary Measures

No sharp-edged or heavy objects may get into contact with the sensor cable sheath.

- ➡ Protect the cable against pressure loads in pressurised rooms.
- ➡ Avoid kinks in any case.
- ➡ Check the connections for tight fit.

i A damaged cable cannot be repaired.

4.2 Sensor

The sensors may be mounted free-standing or flush.

When assembling, make sure that the polished sensor surface is not scratched.

4.2.1 Radial Point Clamping, Circumferential Clamping, Cylindric Sensors

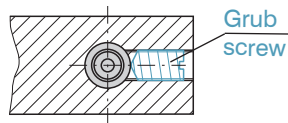

This simple type of fixture is only recommended for a force and vibration-free installation position. The grub screw must be made of plastic so that it cannot damage or deform the sensor housing.

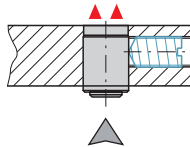
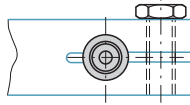

Fig. 7 Radial point clamping with grub screw

NOTICE

Do not use metal grub screws!
> Danger of damaging the sensor



This sensor mounting option offers maximum reliability because the sensor is clamped around its cylindrical housing. It is absolutely necessary in difficult installation environments, for example on machines, production plants et cetera.

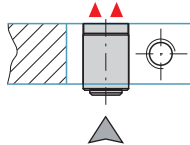
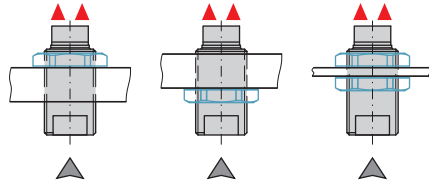

Fig. 8 Circumferential clamping with clamping ring

A circumferential clamping possible from 2 mm behind the front face.

i Tension at the cable is inadmissible!

4.2.2 Mounting with Thread, Series CSEx/Mx Sensors



For holders with an internal thread, a mounting nut is sufficient for attaching the sensor. For thin holders, Micro-Epsilon recommends mounting nuts on both sides for mounting. Attach the sensor preferably at the end of the thread towards the active measuring surface. Please note the maximum torque, see [Fig. 11](#).

Fig. 9 Mounting with thread

▲▲ Active measuring surface sensor, ▲ connector side

4.2.3 Flat Sensors

Screwing from above

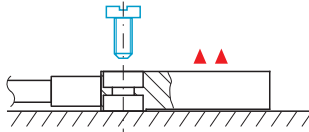

Screwing from bottom

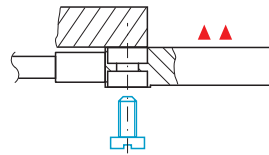

Flat sensors are mounted by means of a tap hole for M2 (in case of sensors 0.2 and 0.5 mm) or by a through hole for M2 screws. The sensors can be bolted on top or below.

▲ ▲ Active measuring surface sensor

Fig. 10 Mounting flat sensors

4.2.4 Dimensional Drawings Sensors

Cylindric sensors

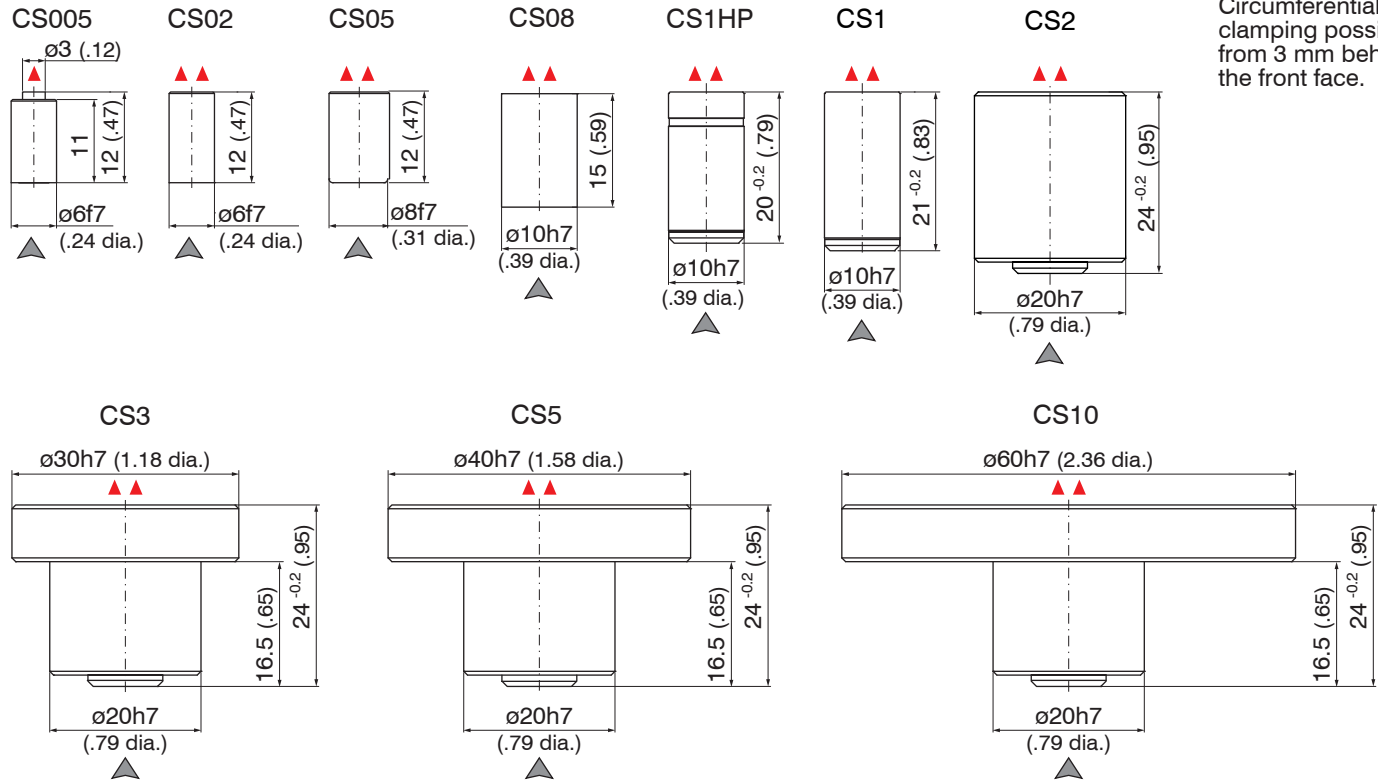

Circumferential clamping possible from 3 mm behind the front face.

▲▲ Active measuring surface sensor, ▲ connector side

Dimensions in mm (inches), dimensional drawings of other sensors are available on request.

CSE05

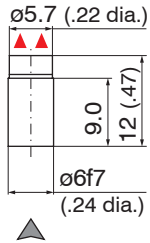

CSE1

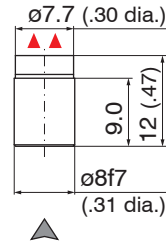

CSE1,25

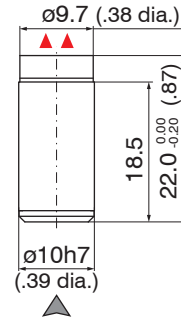

CSE2

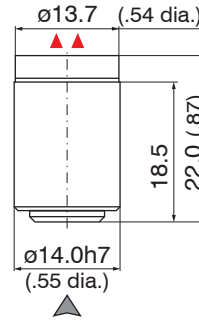

CSE3

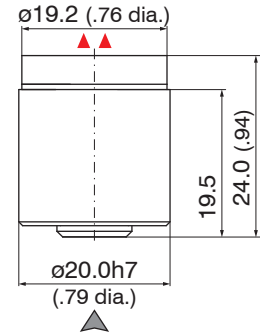

▲ ▲ Active measuring surface sensor, ▲ connector side

Dimensions in mm (inches), dimensional drawings of other sensors are available on request.

CSE05/M8

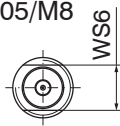

CSE1,25/M12

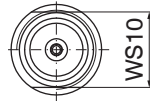

CSE2/M16

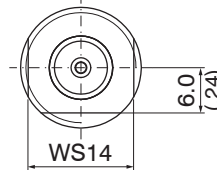

CSE3/M24

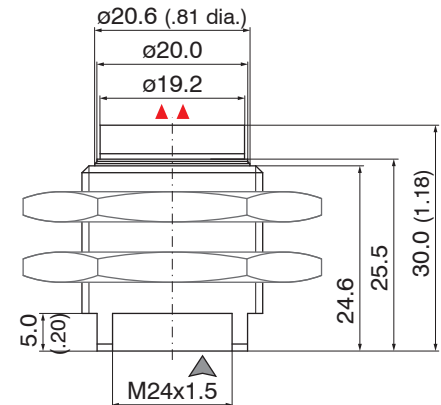
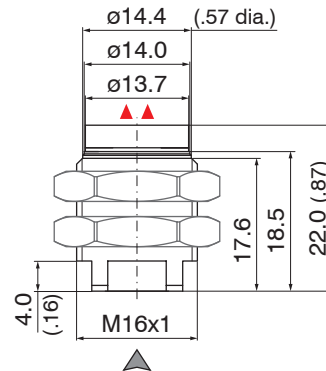
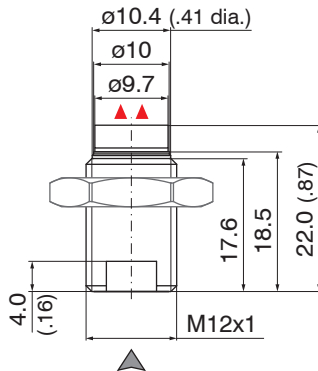
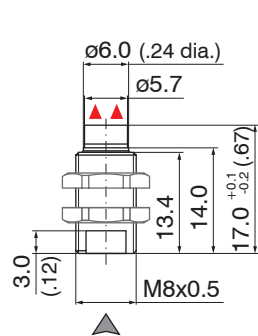
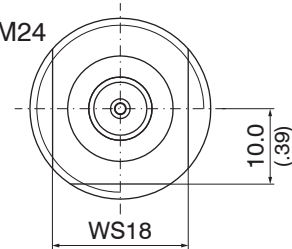

Fig. 11 Cylindrical sensors with thread and male connector

▲ Connector side

Dimensions in mm (inches),
dimensional drawings of other sensors
are available on request.

▲▲ Active measuring surface sensor

Sensor	Torque
CSE05/M8	2.5 Nm max.
CSE1,5/M12	10 Nm max.
CSE2/M16	20 Nm max.
CSE3/M24	70 Nm max.

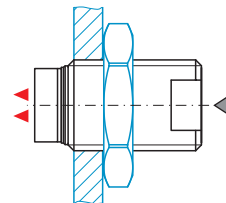

Preferred mounting:

- Screw the sensor into the sensor holder.
- Turn the mounting nut on. Do not exceed torques.

CSH02-CAMx,
CSH05-CAMx

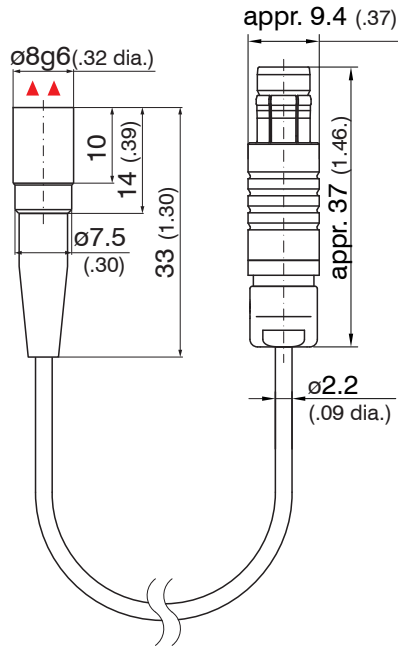

CSH1-CAMx,
CSH1,2-CAMx

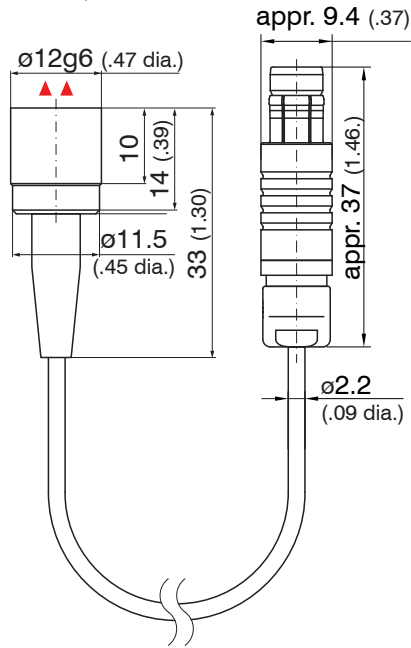

CSH2-CAMx

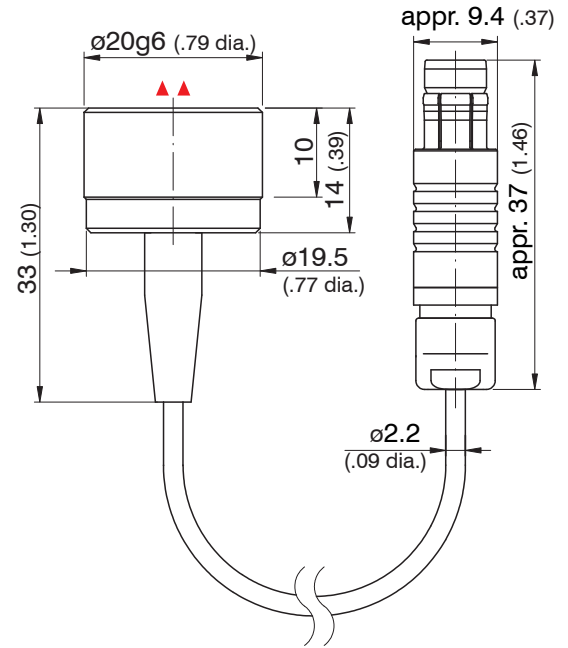

Fig. 12 Cylindrical sensors with integrated cable

Dimensions in mm (inches), dimensional drawings of other sensors are available on request. Circumferential clamping possible from 3 mm behind the front face.

▲▲ Active measuring surface sensor

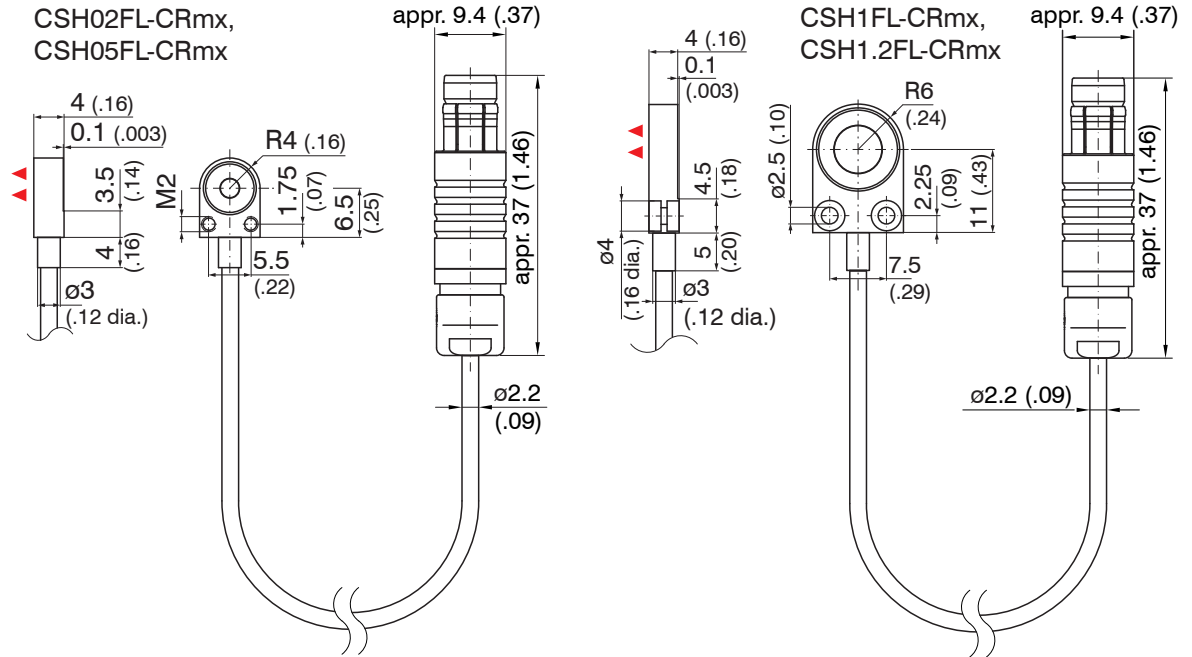
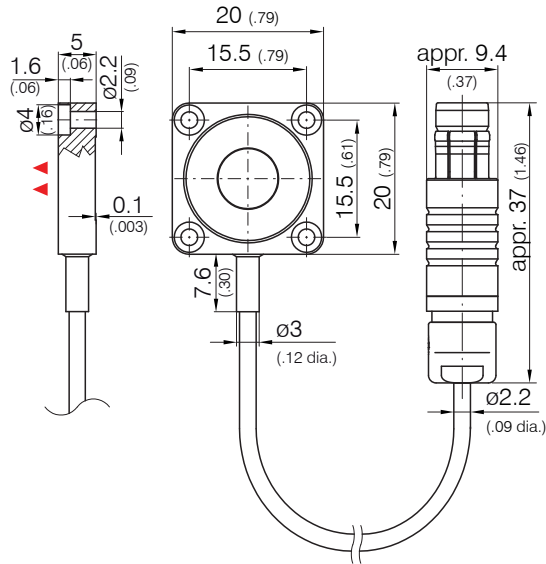

Fig. 13 Flat sensors with integrated cable, measuring range up to 1.2 mm nominal

Dimensions in mm (inches), not to scale

▲▲ Active measuring surface sensor

CSH2FL-CRmx



CSH3FL-CRmx

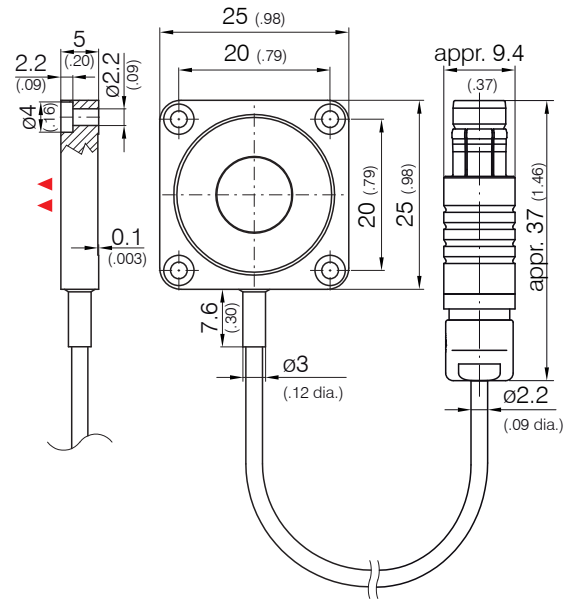

Fig. 14 Flat sensors with integrated cable, measuring range 2 and 3 mm nominal

Cable length 1.4 m visible (incl. crimp sleeve)

Dimensions in mm (inches), not to scale

▲▲ Active measuring surface sensor

4.3 Sensor Cable

4.3.1 General

The sensor is connected to the controller by the sensor cable.

The connection is made by simple plugging. The connector locks automatically. The tight fit can be checked by pulling the connector housing (cable bushing). The lock can be released and the connector can be opened by pulling the knurled housing sleeve of the cable bushing.

4.3.2 Cable with Type C Connector

Type	Cable length	Bending radius
CCmx,xC CCmx,xC/90	1.4 m, 2.8 m 4.2 m	static >7 mm dynamic >15 mm (recommended 25 mm)
CCx,xC CCx,xC/90	1 m, 2 m, 3 m	static >10 mm dynamic >22 mm (recommended 30 mm)
CCgx,xC CCgx,xC/90	1 m, 2 m, 4 m, 6 m, 8 m	

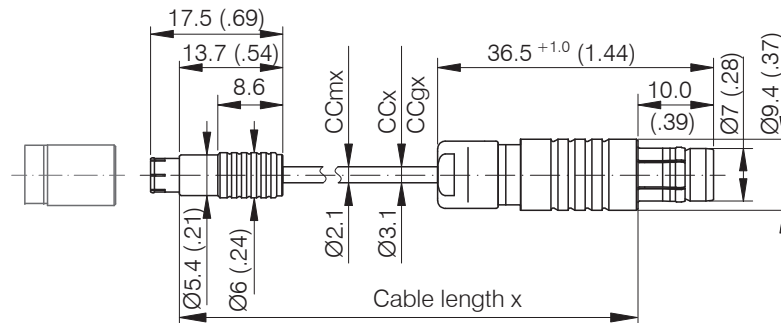

Dimensions in mm (inches)

Fig. 15 Dimensional drawings sensor cables CCxC, CCmxC, CCgxC

Sensor cable suitable for sensors

CS005 | CS02 | CS05 | CS08

CSE05 | CSE05/M8 | CSE1

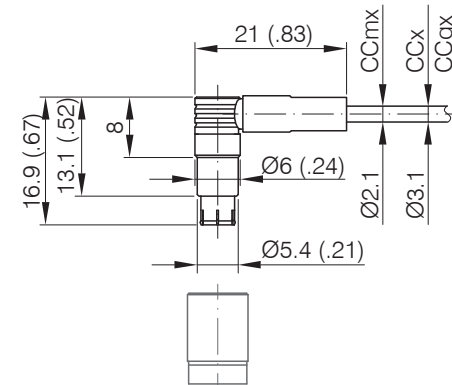

CCxC/90, CCmxC/90 and CCgxC/90

4.3.3 Cable with Type B Connector

Type	Cable length	Bending radius
CCmx,xB CCmx,xB/90	1.4 m, 2.8 m 4.2 m	static >7 mm dynamic >15 mm (recommended 25 mm)
CCx,xB CCx,xB/90	1 m, 2 m, 3 m	static >10 mm dynamic >22 mm (recommended 30 mm)
CCgx,xB CCgx,xB/90	1 m, 2 m, 4 m, 6 m, 8 m	

Sensor cable suitable for sensors
 CS1 | CS1HP | CS2 | CS3 | CS5 | CS10
 CSE1,25/M12 | CSE2 | CSE2/M16 | CSE3
 CSE3/M24

i Sensor cables with connector type B enable to connect to each end both a sensor and a controller.

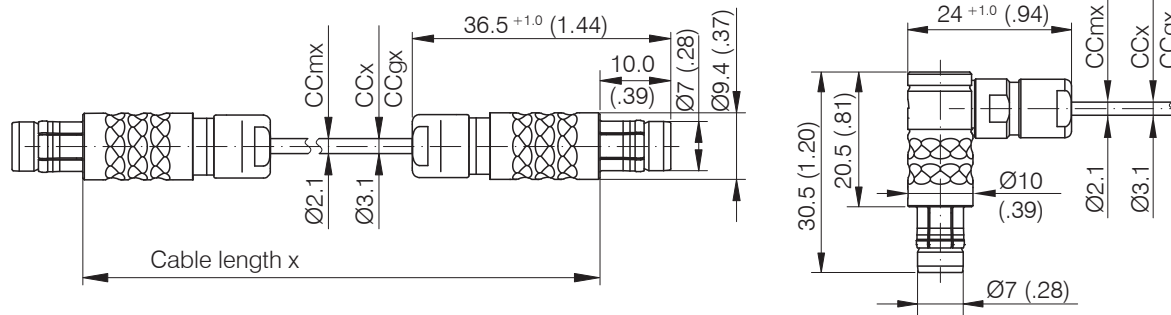

Fig. 16 Dimensional drawings sensor cables CCxB, CCmxB, CCgxB

CCxB/90, CCmxB/90 and CCgxB/90

Dimensions in mm (inches)

4.4 Controller

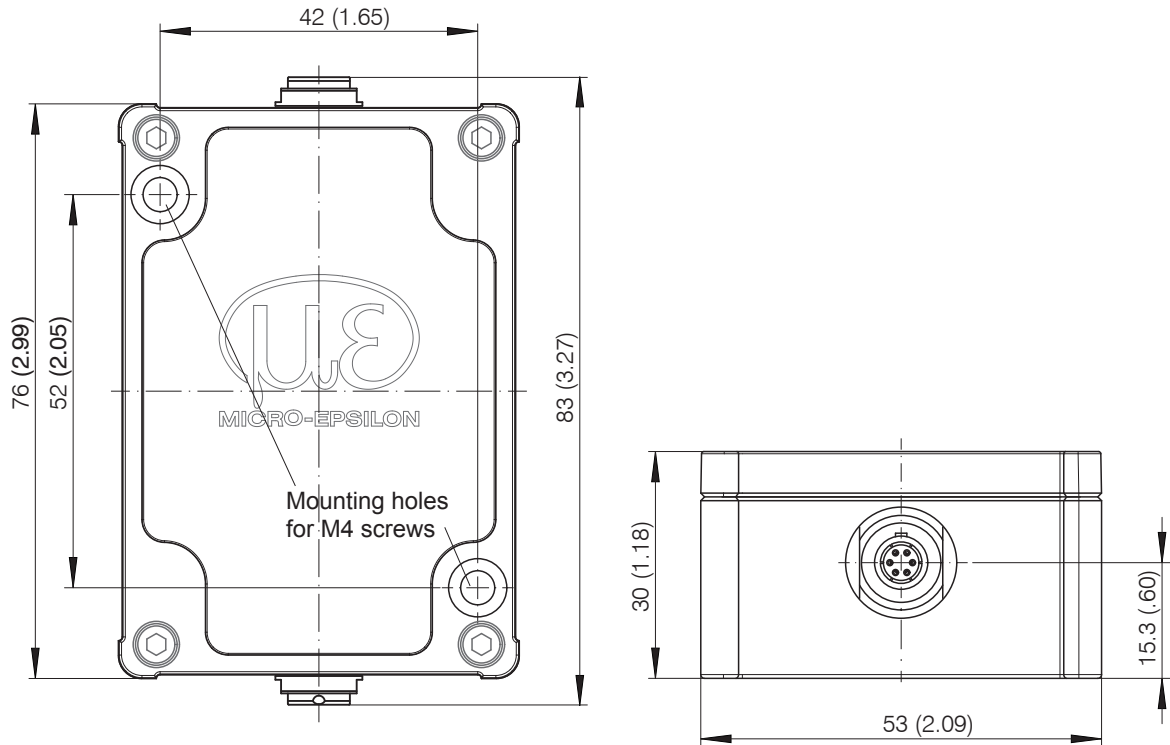

Fig. 17 Dimensional drawing controller

Dimensions in
mm (inches)

4.5 Ground Connection, Earthing

➡ Make sure you have a sufficient grounding of the measuring object, for example connect it with the sensor or the supply ground.

4.6 Power Supply, Display/Output Device DT6110

The power supply and signal output occur via the 5-pin connector on the front side of the controller.

Pin	Color SCAC3/5	Signal	Description
1	white	+24 V	+24 V power supply
2	gray	GND	Supply ground
3	yellow	-	not used
4	green	AGND	Analog ground (for signal output)
5	brown	U-out	Signal output (load, min 10 kOhm)
Shield			Cable shield, housing



View on solder pin side, 5-pin. female cable connector



Fig. 18 Connection Power supply

SCAC3/5 is a 3 m long, pre-assembled power supply and output cable.

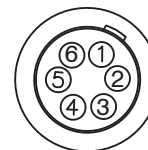

Fig. 19 SCAC3/5 power supply and output cable

4.7 Power Supply, Display/Output Device DT6120

Pin	Color SCAC3/6	Signal	Description
1	white	+24 V	+24 V power supply
2	gray	GND	Supply ground
3	pink	RS485-A	RS485 interface
4	green	AGND	Analog ground (for signal output)
5	brown	U-out	Signal output (Last, min 10 kOhm)
6	blue	RS485_B	RS485 interface
Shield			Cable shield, housing



View on solder pin side, 6-pin. female cable connector



Fig. 20 Connection power supply

SCAC3/6 is a 3 m long, pre-assembled power supply and output cable.



Fig. 21 SCAC3/6 power supply and output cable

4.8 Sensor Connection

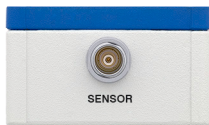

Fig. 22 Connection sensor cable

5. RS485 Interface

The RS485 interface is only present with the DT6120.

You can read the measuring values in digital form via the RS485 interface.

MICRO-EPSILON supports you with the driver MEDAQLib, which contains all commands for the capaNCDT 6120. You can download the driver directly under the link <http://www.micro-epsilon.de/link/software/medaqlib>.

You can also use the IF1032/ETH interface converter, see Chap. A 1, for the configuration and reading of the measuring values via Ethernet.

5.1 Hardware Interface

The interface is a half-duplex RS485 interface (1 common line pair for Rx and Tx).

Baud rate: 230400 (other baud rates adjustable)

Data format: 1 start bit, 8 data bits, 1 parity bit (straight), 1 stop bit

RS485 Address: 126 (1 ... 126 adjustable)

In controller there is no RS485 terminal resistance. For RS485 cables longer than 5 meters a terminal resistance of 120 Ohm between the A and the B line both at the bus start and end is necessary.

5.2 Protocol

The capaNCDT 6120 behaves like a RS485-Slave. Since it is a halfduplex protocol, only the Master can initiate a communication. Each device on the RS485 bus requires a RS485 address. The master sends a request with address on the bus and only the Slave with the address then responds to the request.

5.2.1 Reading Measuring Values

Master: Request Data						
Byte:	SD	DA	SA	FC	FCS	ED
Value:	0x10	x	x	0x4C	x	0x16
FCS						

Slave: Response Data										
Byte:	SD	LE	LE rep	SD rep	DA	SA	FC	Data[]	FCS	ED
Value:	0x68	x	x	0x68	x	x	0x08	x	x	0x16
FCS										

Abbreviations:	
SD	StartDelimiter (0x10: telegram without data; 0x68 telegram with variable length)
LE	Length (number of bytes without SD, LE, LErep, SDrep, FCS, ED)
LErep	LE repeated
SDrep	SD repeated
DA	Destination Address /default 0x7E)
SA	Source Address (e.g. 0x01)
FC	Function Code
FCS	Checksum (sum of all bytes without SD, LE, LErep, SDrep, FCS, ED; without overflow, only 8 bits)
ED	EndDelimiter

Data[] - Measuring data (little endian)

The measuring data consists of a counter, the packet length m and the measuring values. The packet length m determines how many measuring values are transmitted. The packet length m is the number of measuring values sampled from the electronic, since the last request of measuring data, but is limited to the last 20 measuring values. The first measuring value in the data[] packet is the oldest value sampled, the last is the newest value sampled.

Data[0]	Counter [7:0]	unsigned short
Data[1]	Counter [15:8]	
Data[2]	Packet length m [7:0]	unsigned char
Data[3]	Filler byte [7:0]	unsigned char
Data[4]	Measuring value 1 [7:0]	signed integer
Data[5]	Measuring value 1 [15:8]	
Data[6]	Measuring value 1 [23:16]	
Data[7]	Measuring value 1 [31:24]	
Data[8]	Measuring value 2 [7:0]	signed integer
Data[9]	Measuring value 2 [15:8]	
Data[10]	Measuring value 2 [23:16]	
Data[11]	Measuring value 2 [31:24]	
	...	
Data[..]	Measuring value m [7:0]	signed integer
Data[..]	Measuring value m [15:8]	
Data[..]	Measuring value m [23:16]	
Data[..]	Measuring value m [31:24]	

5.2.2 Scaling the Measuring Values

By default, 24-bit measuring values are transmitted. That is why:

0x0 = 0 % of sensor measuring value

0xF0000 = 100 % of sensor measuring value

If the sensor is out of measuring range, so correspondingly larger measuring values are output.

5.2.3 Example of the Measuring Value Transmission

Master: Request Data						
Byte:	SD	DA	SA	FC	FCS	ED
Value:	0x10	x	x	0x4C	x	0x16
				FCS		

DA = Destination address = slave address = 0x7E

SA = Source address = master address = 0x01

FCS = Checksum = 0x7E+0x01+0x43 = 0xC2

Slave: Response Data										
Byte:	SD	LE	LE rep	SD rep	DA	SA	FC	Data	FCS	ED
Value:	0x68	0x13	0x13	0x68	0x01	0x7E	0x08	e.g. 16 bytes	x	0x16
							FCS			

LE = Length = 16 data bytes + 3 bytes (DA, SA, FC) = 19 bytes = 0x13

DA = Destination address = master address = 0x01

SA = Source address = slave address = 0x7E

FCS = Checksum = 0x01 + 0x7E +

	Value	Name	Explanation
Data[0]	0x22	Counter [7:0]	Measuring value counter = 0x0122 = 290
Data[1]	0x01	Counter [15:8]	
Data[2]	0x03	Packet length m [7:0]	m = 3 -> 3 meas. values
Data[3]	0x00	Filler byte [7:0]	filler, can be ignored
Data[4]	0xB1	Measuring value 1 [7:0]	meas. value = 0x003244B1 (0xF00000 = 100 %) -> 0x003244B1 = 20.945 % e.g. 200 μm sensor -> 41.89 μm
Data[5]	0x44	Measuring value 1 [15:8]	
Data[6]	0x32	Measuring value 1 [23:16]	
Data[7]	0x00	Measuring value 1 [31:24]	
Data[8]	0xAC	Measuring value 2 [7:0]	Next measurement value, see above
Data[9]	0x44	Measuring value 2 [15:8]	
Data[10]	0x32	Measuring value 2 [23:16]	
Data[11]	0x00	Measuring value 2 [31:24]	
Data[12]	0xB9	Measuring value 3 [7:0]	Next measurement value, see above
Data[13]	0x44	Measuring value 3 [15:8]	
Data[14]	0x32	Measuring value 3 [23:16]	
Data[15]	0x00	Measuring value 3 [31:24]	

A total of 3 measurement values (= m) were added since the last measuring value request in controller and transferred thereby.

5.2.4 Setting the RS485 Address

The RS485 address of controller can be changed with this telegram:

Master:														
SD	LE	LE	SD	DA	SA	FC	DSAP	SSAP	new_addr	ID_Hi	ID_Lo	Lock	FCS	ED
0x68	0x09	rep	rep	x	x	0x43	0x37	0x3E	x	0x0	0x0	0x0	x	0x16

DA Destination Address (= old Slave address)

SA Source Address = Master Address (e.g. 0x01)

FCS Checksum (sum of all bytes without SD, LE, LErep, SDrep, FCS, ED; without overflow, only 8 bits)

New_addr New address (in range 1...126)

Answer Slave (short acknowledgement), on success:

SC
0xE5

No response:

No response indicates that an error has occurred in the address alignment. The controller still has the old address.

The new address is valid only after a reboot of the controller.

5.3 Commands and Settings

It can be made even more settings via the RS485 interface:

- Filter:
 - off
 - moving average (about 2 to 8 values)
 - arithmetic average (about 2 to 8 values)
 - Median (about 2 to 8 values)
 - dynamic noise reduction
- Data rate at which the measuring values can be added:
 - 5, 10, 20, 40, 80, 160, 320, 640, 1000 or 2000 Samples/s
- Baud rate of RS485 interface:
 - 9600, 115200, 230400, 460800 or 921600 Baud
- RS485 address of controller: 1 ... 126
- Firmware Update of controller

i Use for these settings either our MEDAQLib driver or the IF1032/ETH interface converter to Ethernet with the appropriate configuration option via web interface.

6. Operation

➡ Connect the display/output devices through the signal output socket, see Chap. 4.6, before connecting the device to the power supply and switching on the power supply.

The measuring system is delivered calibrated. Calibration by the user is not necessary.

i Allow the measuring system to warm up for about 10 minutes before the first measurement.

NOTICE

The power supply may not exceed or continuously fall below the specified limits.

> Damage to or destruction of the sensor and/or controller

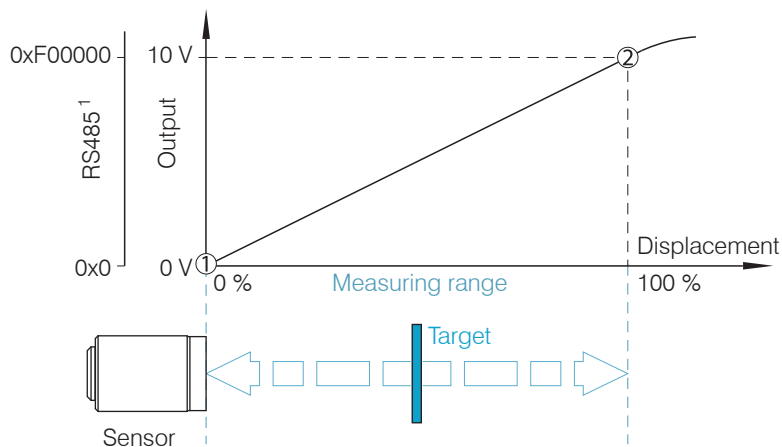

1 = Start of measuring range

2 = End of measuring range

Fig. 23 Signal characteristic in the measuring range

CAUTION

Disconnect the power supply before touching the sensor surface.

- > Static discharge
- > Danger of injury

1) Digital interface with controller DT6120 or DT6120/ECL2 only.

7. Maintenance

Make sure that the sensor surface is always clean.

➡ Switch off the power supply before cleaning.

➡ Clean with a clamp cloth; then rub the sensor surface dry.



Disconnect the power supply before touching the sensor surface.

> Static discharge

> Danger of injury

If the controller, the sensor or the sensor cable is defective, please send us the effected parts for repair or exchange. In the case of faults the cause of which is not clearly identifiable, send the whole measuring system back to

MICRO-EPSILON MESSTECHNIK
GmbH & Co. KG
Königbacher Str. 15
94496 Ortenburg / Germany

Tel. +49 (0) 8542 / 168-0
Fax +49 (0) 8542 / 168-90
info@micro-epsilon.de
www.micro-epsilon.com

Sensors of the same type can be replaced without calibrating the controller.

8. Liability for Material Defects

All components of the device have been checked and tested for functionality at the factory. However, if defects occur despite our careful quality control, MICRO-EPSILON or your dealer must be notified immediately. The liability for material defects is 12 months from delivery.

Within this period, defective parts, except for wearing parts, will be repaired or replaced free of charge, if the device is returned to MICRO-EPSILON with shipping costs prepaid. Any damage that is caused by improper handling, the use of force or by repairs or modifications by third parties is not covered by the liability for material defects. Repairs are carried out exclusively by MICRO-EPSILON.

Further claims can not be made. Claims arising from the purchase contract remain unaffected. In particular, MICRO-EPSILON shall not be liable for any consequential, special, indirect or incidental damage. In the interest of further development, MICRO-EPSILON reserves the right to make design changes without notification. For translations into other languages, the German version shall prevail.

9. Decommissioning, Disposal

➡ Remove the cable for electrical power and output signal from the controller.

Incorrect disposal may cause harm to the environment.

➡ Dispose of the device, its components and accessories, as well as the packaging materials in compliance with the applicable country-specific waste treatment and disposal regulations of the region of use.

Appendix

A 1 Optional Accessories

PS2020		<p>Power supply for DIN rail mounting Input 100 - 240 VAC Output 24 VDC / 2.5 A; L/W/H 120 x 120 x 40 mm Built-in type; mounting on symmetrical DIN-rail 35 mm x 7.5 mm, DIN 50022</p>
PS2401/100-240/24V/1A		<p>Wall power supply; universal power supply open ends; changeable inserts; internationally usable</p>
IF1032/ETH		<p>Interface module Ethernet/EtherCAT - at DT6120: RS485 to Ethernet/EtherCAT (24-bit resolution) - at DT6110: Analog output to Ethernet/EtherCAT (only 14-bit resolution)</p>

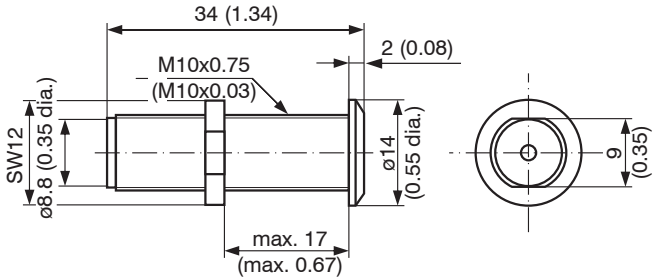
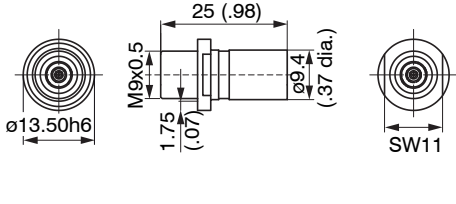
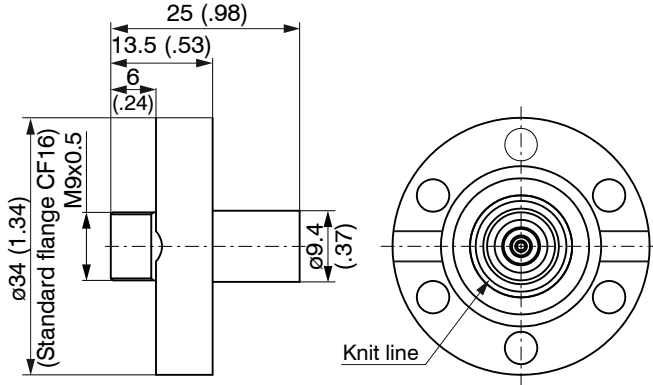
<p>SWH.OS.650.CTMSV</p>		<p>Vacuum feed through, Max. leak rate 1×10^{-7} mbar · l s⁻¹ Compatible with connector type B</p>
<p>UHV/B</p>		<p>Vacuum feed through triax weldable Max. leak rate 1×10^{-9} mbar · l s⁻¹ Compatible with connector type B</p>
		<p>Vacuum feed through triax with CF16 flange Max. leak rate 1×10^{-9} mbar · l s⁻¹ Compatible with connector type B</p>

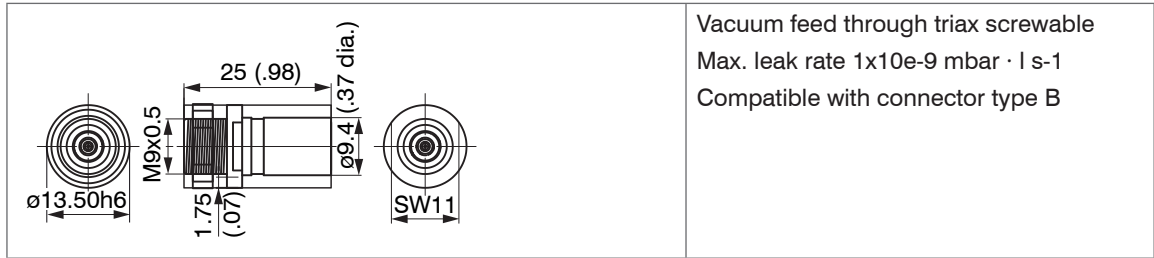

A 2 Tilt Angle Influence on the Capacitive Sensor

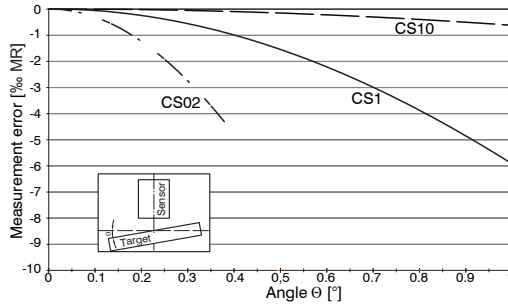

Fig. 24 Example of measuring range deviation in the case of a sensor distance of 10 % of the measuring range

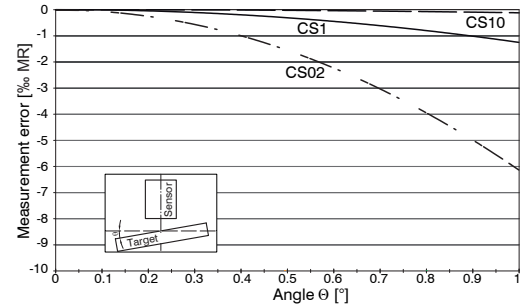

Fig. 25 Example of measuring range deviation in the case of a sensor distance of 50 % of the measuring range

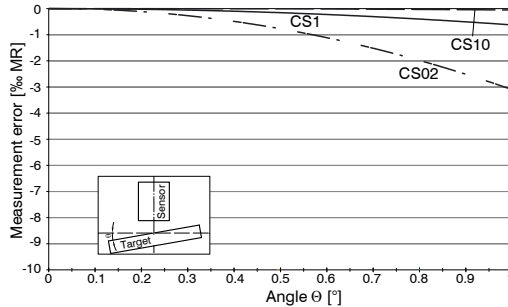

Fig. 26 Example of measuring range deviation in the case of a sensor distance of 100 % of the measuring range

i Figures give an influence example shown on the sensors CS02/CS1 and CS10 in the case of different sensor distances to the target. As this results from internal simulations and calculations, please request for detailed information.

A 3 Measurement on Narrow Targets

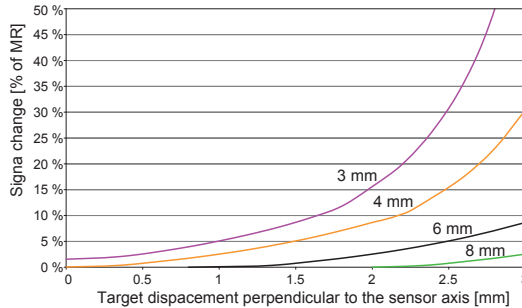

Fig. 27 Example of measuring range deviation in the case of a sensor distance of 10 % of the measuring range

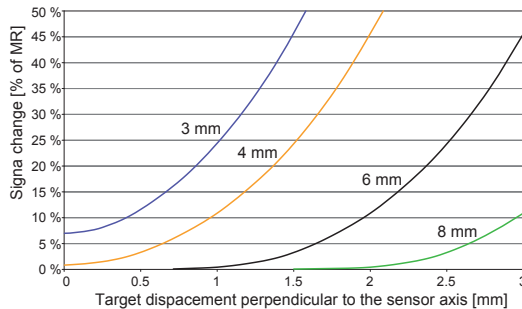

Fig. 29 Example of measuring range deviation in the case of a sensor distance of 100 % of the measuring range

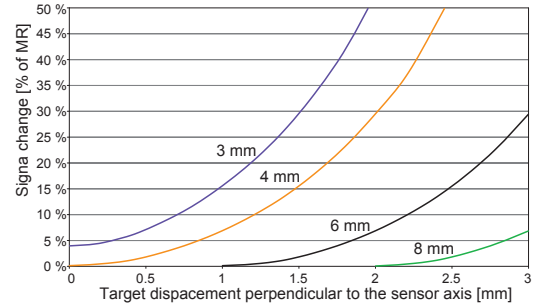

Fig. 28 Example of measuring range deviation in the case of a sensor distance of 50 % of the measuring range

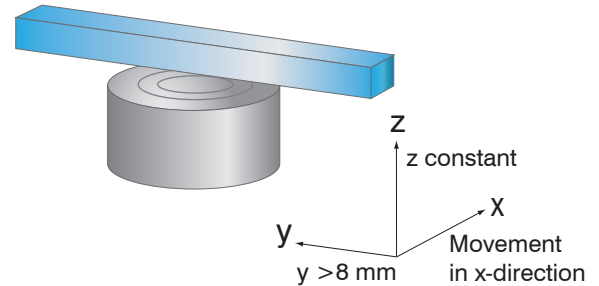

Fig. 30 Signal change in the case of displacement of thin targets in the opposite direction to the measurement direction

i Figures give an influence example shown on the sensors CS05 in the case of different sensor distances to the target as well as target widths. As this results from internal simulations and calculations, please request for detailed information.

A 4 Measurements on Balls and Shafts

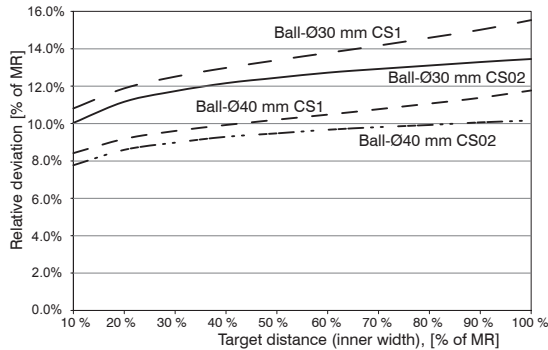

Fig. 31 Measuring value deviation in the case of measurement on ball-shaped targets

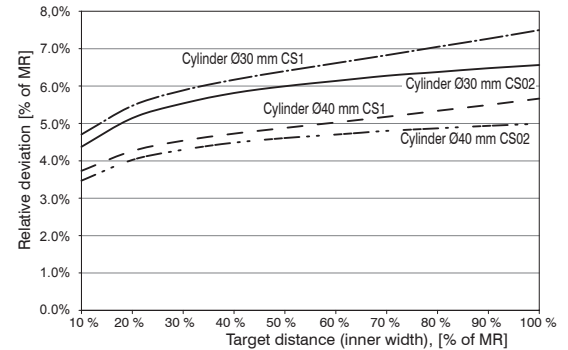

Fig. 32 Measuring value deviation in the case of measurement on cylindrical targets

i Figures give an influence example shown on the sensors CS02 and CS1 in the case of different sensor distances to the target as well as target diameters. As this results from internal simulations and calculations, please request for detailed information.



MICRO-EPSILON MESSTECHNIK GmbH & Co. KG
Königbacher Str. 15 · 94496 Ortenburg / Germany
Tel. +49 (0) 8542 / 168-0 · Fax +49 (0) 8542 / 168-90
info@micro-epsilon.de · www.micro-epsilon.com

X9751316-B071039MSC

© MICRO-EPSILON MESSTECHNIK

